

## Features

- 100V/35A,  
 $R_{DS(ON)} = 40m\Omega(Typ.)@V_{GS}=10V$
- Low  $R_{DS(ON)}$
- Planar Technology
- Reliable and Rugged

## Applications

- Uninterruptible Power Supply
- Battery Power Management



Halogen-Free

## Pin Description

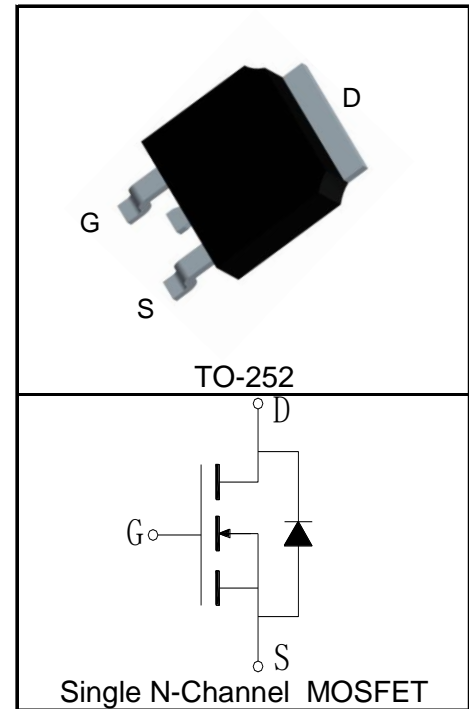

## Absolute Maximum Ratings

Symbol	Parameter	Rating	Unit
<b>Common Ratings</b> ( $T_C=25^\circ\text{C}$ Unless Otherwise Noted)			
$V_{DSS}$	Drain-Source Voltage	100	V
$V_{GSS}$	Gate-Source Voltage	$\pm 20$	
$T_J$	Maximum Junction Temperature	175	$^\circ\text{C}$
$T_{STG}$	Storage Temperature Range	-55 to 175	$^\circ\text{C}$
$I_S$	Diode Continuous Forward Current	$T_C=25^\circ\text{C}$ 35	A
<b>Mounted on Large Heat Sink</b>			
$I_{DP}^{①}$	300 $\mu\text{s}$ Pulse Drain Current Tested	$T_C=25^\circ\text{C}$ 140	A
$I_D^{②}$	Continuous Drain Current( $V_{GS}=10V$ )	$T_C=25^\circ\text{C}$ 35	A
		$T_C=100^\circ\text{C}$ 25	
$P_D$	Maximum Power Dissipation	$T_C=25^\circ\text{C}$ 156	W
		$T_C=100^\circ\text{C}$ 78	
$R_{\theta JC}$	Thermal Resistance-Junction to Case	0.96	$^\circ\text{C}/\text{W}$
$R_{\theta JA}^{③}$	Thermal Resistance-Junction to Ambient	100	$^\circ\text{C}/\text{W}$
<b>Drain-Source Avalanche Ratings</b>			
$E_{AS}^{④}$	Avalanche Energy, Single Pulsed	196	mJ

**Electrical Characteristics** ( $T_C=25^\circ\text{C}$  Unless Otherwise Noted)

Symbol	Parameter	Test Condition	KS1203DAP			Unit
			Min.	Typ.	Max.	
<b>Static Characteristics</b>						
$BV_{DSS}$	Drain-Source Breakdown Voltage	$V_{GS}=0V, I_{DS}=250\mu A$	100	115		V
$I_{DSS}$	Zero Gate Voltage Drain Current	$V_{DS}=100V, V_{GS}=0V$			1	$\mu A$
		$T_J=125^\circ\text{C}$			30	
$V_{GS(th)}$	Gate Threshold Voltage	$V_{DS}=V_{GS}, I_{DS}=250\mu A$	2	3	4	V
$I_{GSS}$	Gate Leakage Current	$V_{GS}=\pm 20V, V_{DS}=0V$			$\pm 100$	nA
$R_{DS(ON)}^{(5)}$	Drain-Source On-state Resistance	$V_{GS}=10V, I_{DS}=20A$		40	50	m $\Omega$
<b>Diode Characteristics</b>						
$V_{SD}^{(5)}$	Diode Forward Voltage	$I_{SD}=20A, V_{GS}=0V$		0.89	1.2	V
$t_{rr}$	Reverse Recovery Time	$I_{SD}=20A, di_{SD}/dt=100A/\mu s$		105		ns
$Q_{rr}$	Reverse Recovery Charge			480		nC
<b>Dynamic Characteristics<sup>(6)</sup></b>						
$R_G$	Gate Resistance	$V_{GS}=0V, V_{DS}=0V, F=1\text{MHz}$		1.6		$\Omega$
$C_{iss}$	Input Capacitance	$V_{GS}=0V,$ $V_{DS}=50V,$ Frequency=1.0MHz		1950		pF
$C_{oss}$	Output Capacitance			265		
$C_{riss}$	Reverse Transfer Capacitance			60		
$t_{d(ON)}$	Turn-on Delay Time	$V_{DD}=50V, I_{DS}=20A,$ $V_{GEN}=10V, R_G=3\Omega$		12		ns
$t_r$	Turn-on Rise Time			33		
$t_{d(OFF)}$	Turn-off Delay Time			42		
$t_f$	Turn-off Fall Time			28		
<b>Gate Charge Characteristics<sup>(6)</sup></b>						
$Q_g$	Total Gate Charge	$V_{DS}=50V, V_{GS}=10V,$ $I_{DS}=20A$		52		nC
$Q_{gs}$	Gate-Source Charge			11		
$Q_{gd}$	Gate-Drain Charge			18		

- Notes:
- ① Pulse width limited by safe operating area.
  - ② Calculated continuous current based on maximum allowable junction temperature.
  - ③ When mounted on 1 inch square copper board,  $t \leq 10\text{sec}$ . The value in any given application depends on the user's specific board design.
  - ④ Limited by  $T_{Jmax}, I_{AS} = 28A, L = 0.5\text{mH}, V_{DD} = 48V, R_G = 25\Omega$ , Starting  $T_J = 25^\circ\text{C}$ .
  - ⑤ Pulse test; Pulse width  $\leq 300\mu s$ , duty cycle  $\leq 2\%$ .
  - ⑥ Guaranteed by design, not subject to production testing.

**Ordering and Marking Information**

Device	Package	Packaging	Quantity	Reel Size	Tape width
KS1203DAP	TO-252	Tape&Reel	2500	13"	16mm

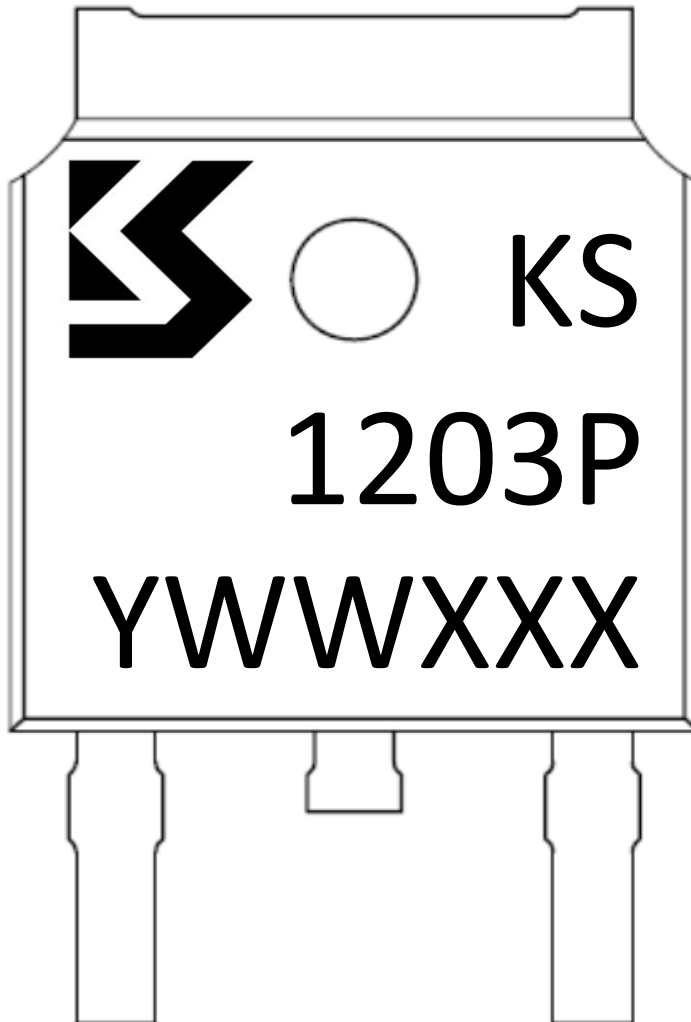

Y =Year,2017-A,2018-B,etc.

WW =Week.

XXX =Lot number.

### Typical Characteristics

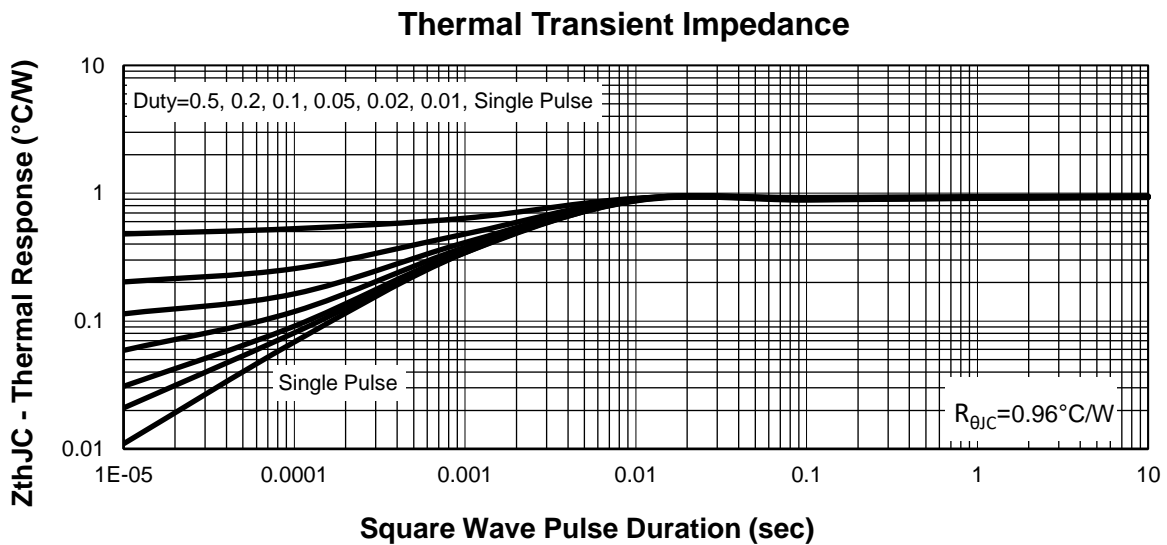
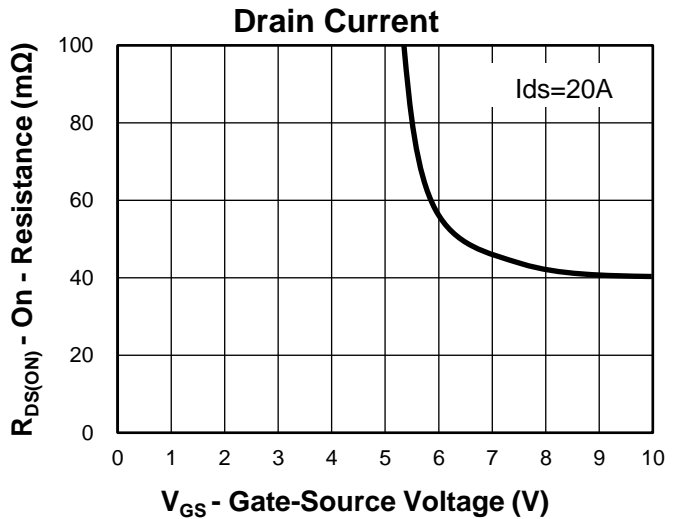
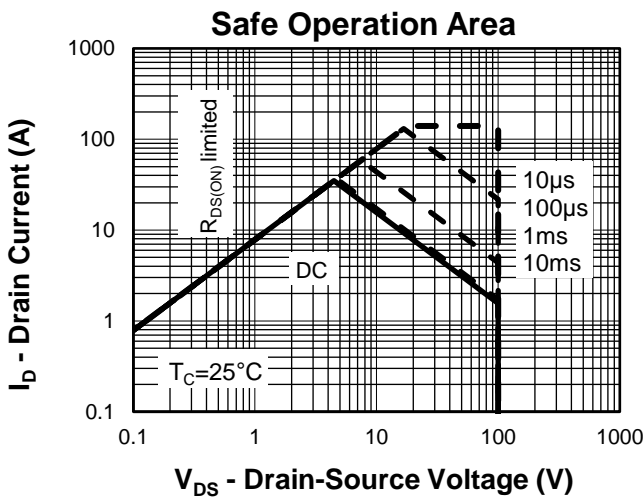
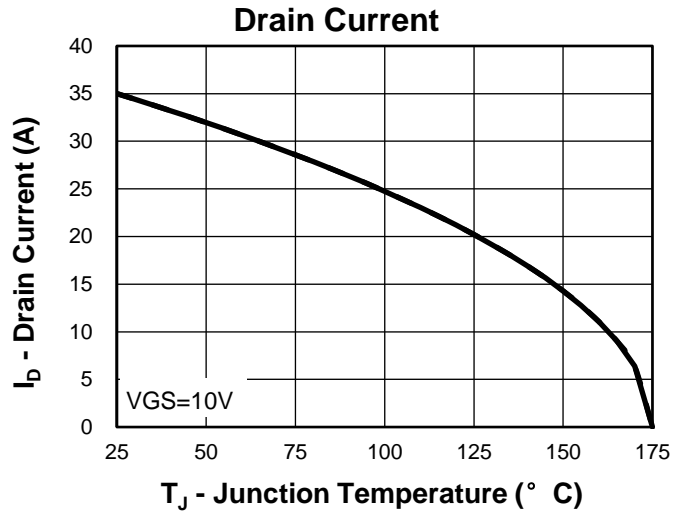
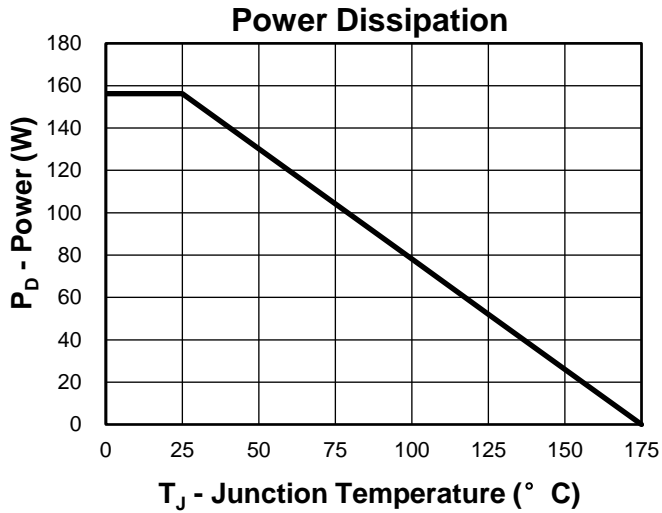

### Typical Characteristics

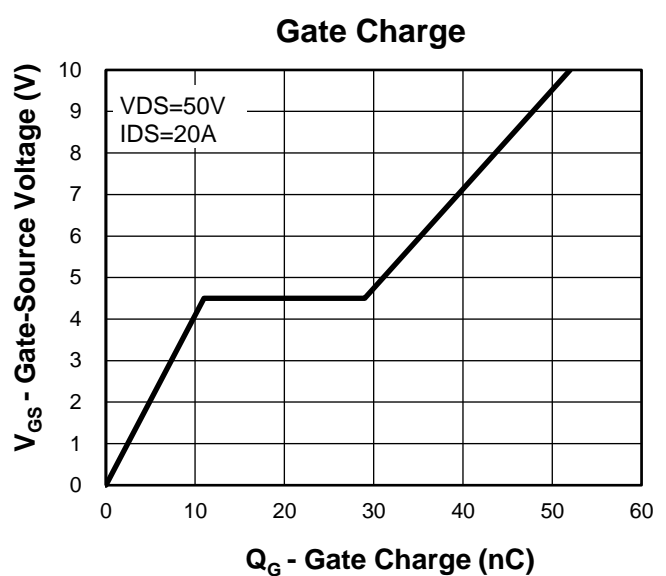
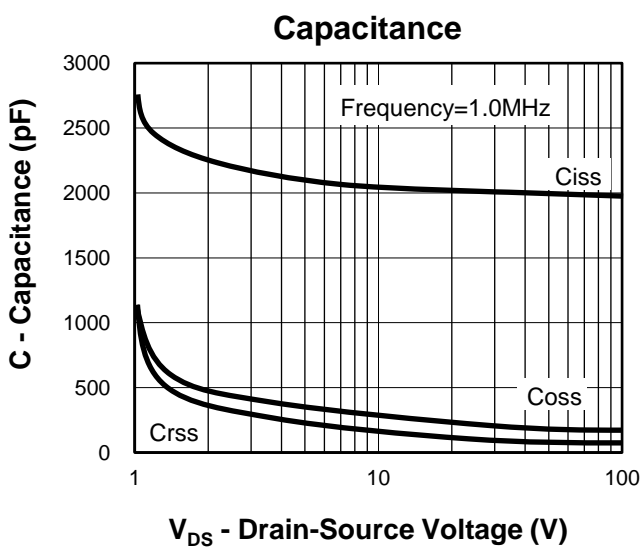
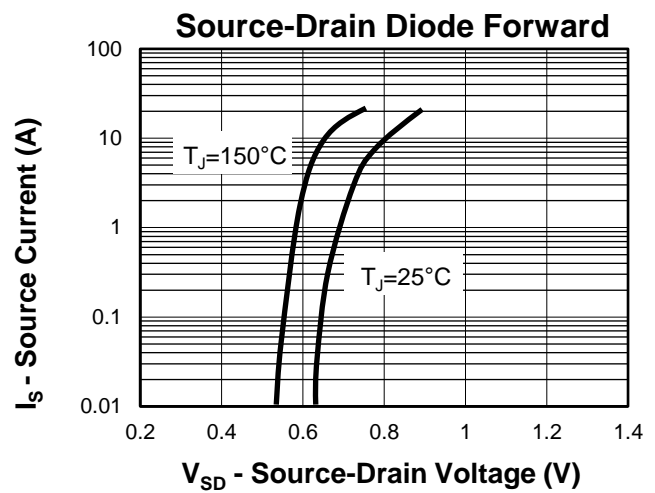
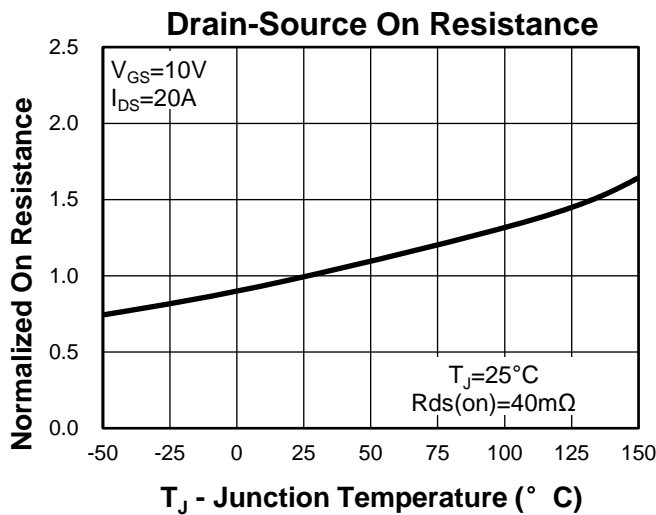
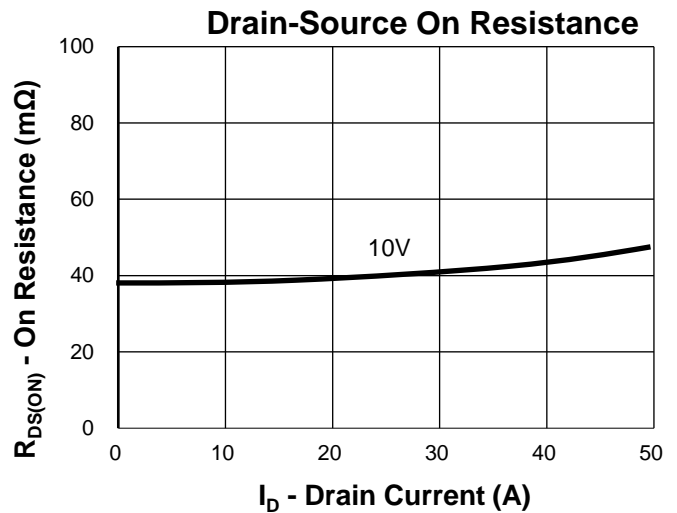
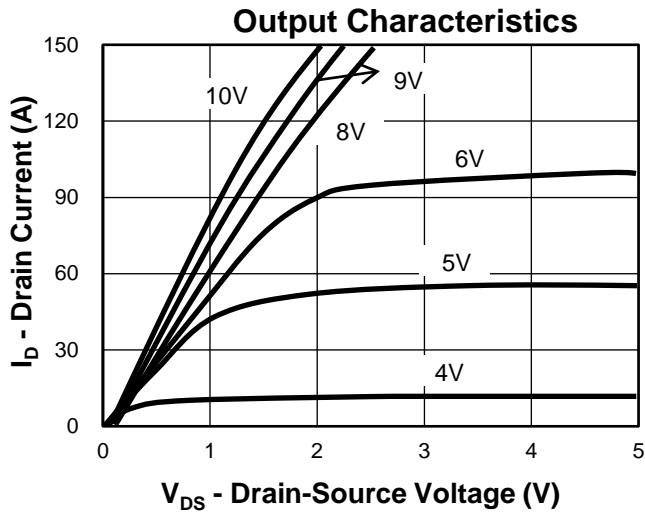

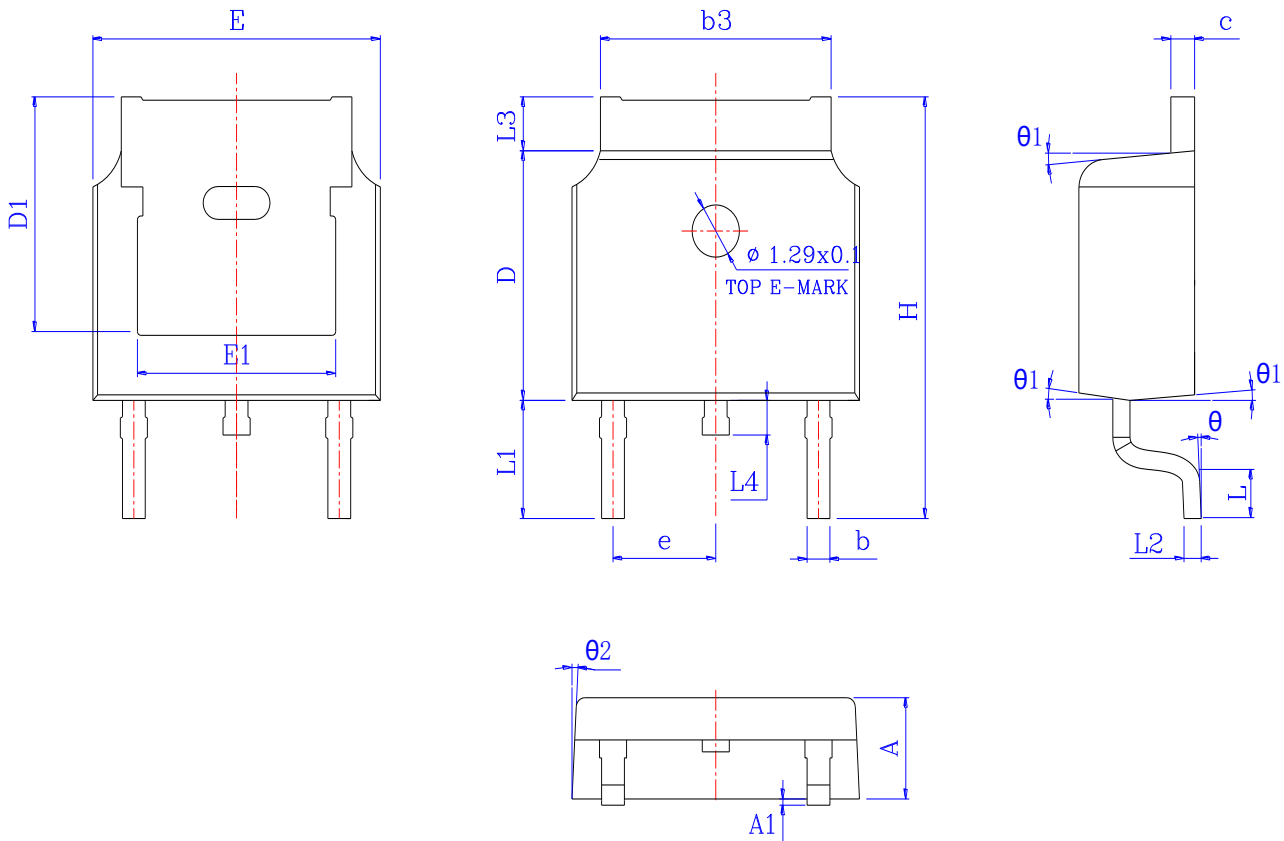
**Package Information**
**TO-252**

SYMBOL	MM			INCH		
	MIN	NOM	MAX	MIN	NOM	MAX
A	2.200	2.300	2.400	0.087	0.091	0.094
A1	*	*	0.100	*	*	0.004
b	0.660	0.760	0.860	0.026	0.030	0.034
b3	5.130	5.295	5.460	0.202	0.208	0.215
c	0.470	0.535	0.600	0.019	0.021	0.024
D	6.000	6.100	6.200	0.236	0.240	0.244
D1	5.30 REF			0.20 REF		
E	6.500	6.600	6.700	0.256	0.260	0.264
E1	4.700	4.810	4.920	0.185	0.189	0.194
e	2.28 REF			0.09 REF		
H	9.800	10.100	10.400	0.386	0.398	0.409
L	1.400	1.550	1.700	0.055	0.061	0.067
L1	2.743 REF			0.108 REF		
L2	0.510 BSC			0.020 BSC		
L3	0.900	1.075	1.250	0.035	0.042	0.049
L4	0.600	0.800	1.000	0.024	0.031	0.039
$\theta$	0°	*	8°	0°	*	8°
$\theta 1$	5°	7°	9°	5°	7°	9°
$\theta 2$	5°	7°	9°	5°	7°	9°

### Avalanche Test Circuit and Waveforms



### Switching Time Test Circuit and Waveforms



### Diode Recovery Test Circuit and Waveforms



### Gate Charge Test Circuit and Waveform



### Customer Service

Kwansemi Semiconductor Co.,Ltd

Email:Sales@kwansemi.com

Web:www.kwansemi.com

### DISCLAIMER:

Kwansemi reserves the right to change the specifications and circuitry without notice at any time. The Products are not designed for use in hostile environments, including, without limitation, aircraft, nuclear power generation, medical appliances, and devices or systems in which malfunction of any Product can reasonably be expected to result in a personal injury. Seller's customers using or selling Seller's products for use in such applications do so at their own risk and agree to fully defend and indemnify Seller.