

Step-up DC/DC Converter with Shutdown Function

No. EA-284-200901

OUTLINE

The R1204x is a low supply current PWM step-up DC/DC converter. Internally, a single IC consists of an NMOS FET, an oscillator, a PWM comparator, a voltage reference unit, an error amplifier, a current limit circuit, an under voltage lockout circuit (UVLO), an over-voltage protection circuit (OVP), a soft-start circuit, a maximum duty cycle limit circuit, and a thermal shutdown protection circuit. By simply using an inductor, a resistor, capacitors and a diode as external components, a high-efficiency step-up DC/DC converter can be easily configured. As protection functions, the IC contains a thermal shutdown protection circuit, a current limit circuit, an OVP circuit, and an UVLO circuit. A thermal shutdown circuit detects overheating of the ICs and stops the operation to protect it from damage. A current limit circuit limits the peak current of Lx, and an OVP circuit detects the over voltage of output, and an UVLO circuit detects the low input voltage.

The R1204x provides the R1204xxxA/D/G/H versions, which are optimized for serial driving of white LEDs with constant current, and the R1204xxxB/C/E/F versions, which are optimized for constant voltage driving. Among the R1204xxxB/C/E/F versions, only the R1204xxxC/F versions are equipped with PWM/VFM auto-switching controls. The LED current can be determined by the value of current setting resistor. The brightness of the LEDs can be quickly adjusted by applying a PWM signal (200 Hz to 300 kHz) to the CE pin. The R1204x is available in DFN(PLP)1820-6 and TSOT-23-6 packages.

FEATURES

- Input Voltage Range.....2.3 V to 5.5 V
- Supply CurrentTyp. 800 μ A
- Standby CurrentMax. 5 μ A
- Feedback Voltage0.2 V \pm 10 mV (R1204xxxxA/D)
0.4 V \pm 10 mV (R1204xxxxG/H)
- V \pm 15 mV (R1204xxxxB/C/E/F)
- Lx Current Limit FunctionMin. 700 mA
- Over Voltage Protection23 V, 33 V, 42 V
- Oscillator FrequencyTyp. 1.0 MHz (R1204xxxxA/B/C/G)
Typ. 750 kHz (R1204xxxxD/E/F/H)
- Maximum Duty CycleMin. 91% (R1204xxxxA/B/C/G)
Min. 92% (R1204xxxxD/E/F/H)
- FET ON ResistanceTyp. 0.8 Ω
- UVLO Function
- Thermal Protection Function
- LED Dimming Control for R1204xxxxA/Dby external PWM signal (200 Hz to 300 kHz frequency)
- PackagesDFN(PLP)1820-6, TSOT-23-6
- Recommended Bypass Capacitor1.0 μ F

APPLICATIONS

- Constant voltage power source for hand-held equipment
- OLED power supply for hand-held equipment
- White LED driver for hand-held equipment

R1204x

No. EA-284-200901

SELECTION GUIDE

The package type, the OVP detector threshold, the feedback voltage and the PWM//VFM auto-switching control are user-selectable options as described below.

Selection Guide

Product Name	Package	Quantity per Reel	Pb Free	Halogen Free
R1204Kxy2z-TR	DFN(PLP)1820-6	5,000 pcs	Yes	Yes
R1204Nxy3z-TR-FE	TSOT-23-6	3,000 pcs	Yes	Yes

x: OVP Detector Threshold

1: 23 V

2: 33 V

3: 42 V

y: Current Limit

1: Typ. 900 mA

z: Feedback Voltage, Oscillator Frequency, PWM/VFM Auto-Switching Control

z	Feedback Voltage	Oscillator Frequency	PWM/VFM Auto-Switching Control
A	Typ. 0.2 V	Typ. 1 MHz	No
B	Typ. 1 V		No
C	Typ. 1 V		Yes
D	Typ. 0.2 V	Typ. 750 kHz	No
E	Typ. 1 V		No
F	Typ. 1 V		Yes
G	Typ. 0.4 V	Typ. 1 MHz	No
H		Typ. 750 kHz	

BLOCK DIAGRAMS

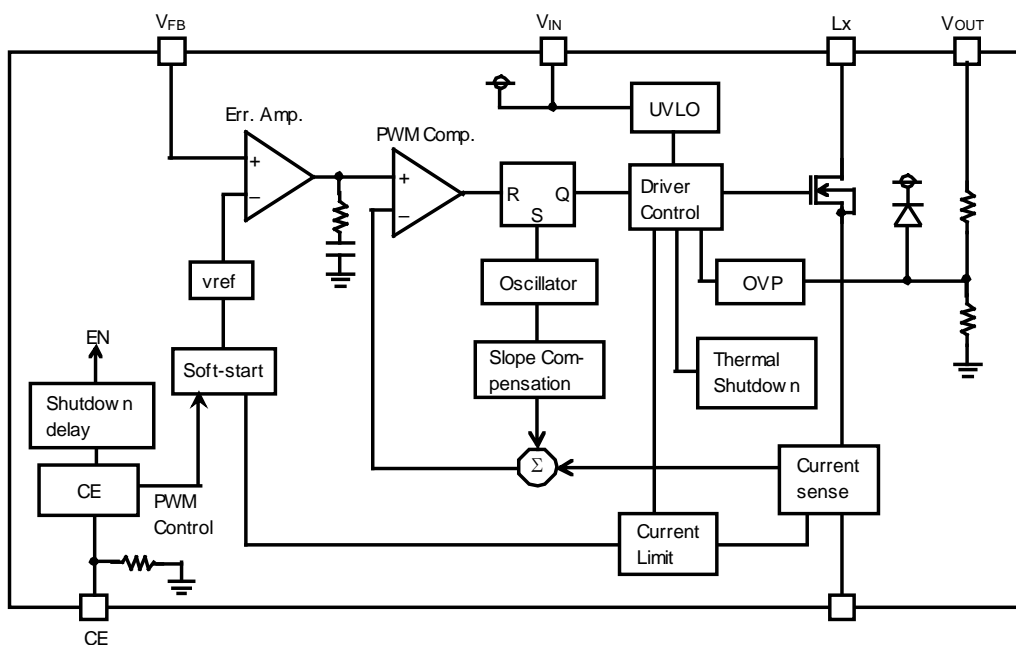

R1204xxxxA/D/G/H Block Diagram

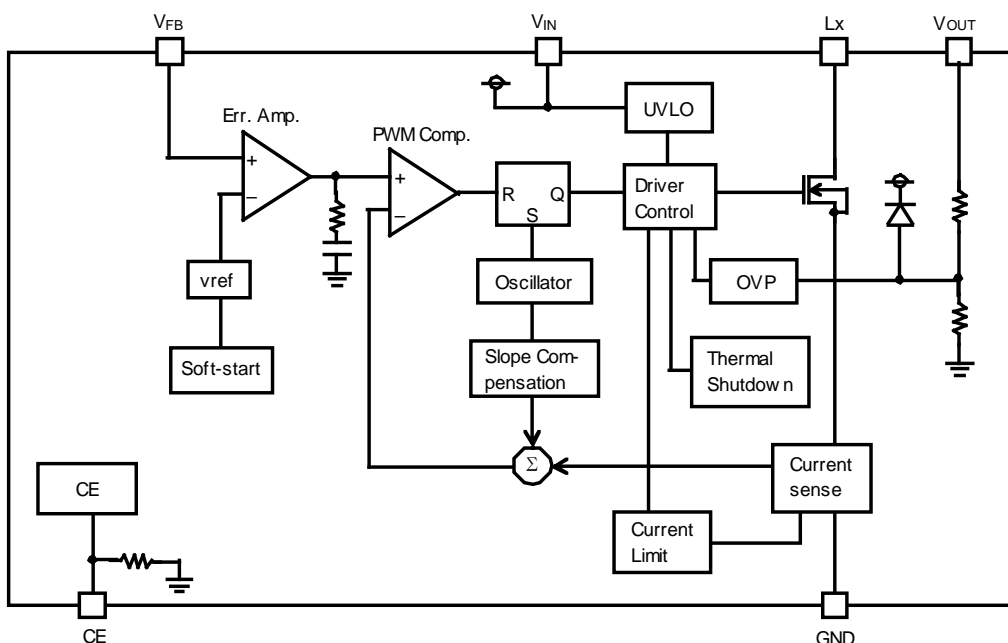

R1204xxxxB/E Block Diagram

R1204x

No. EA-284-200901

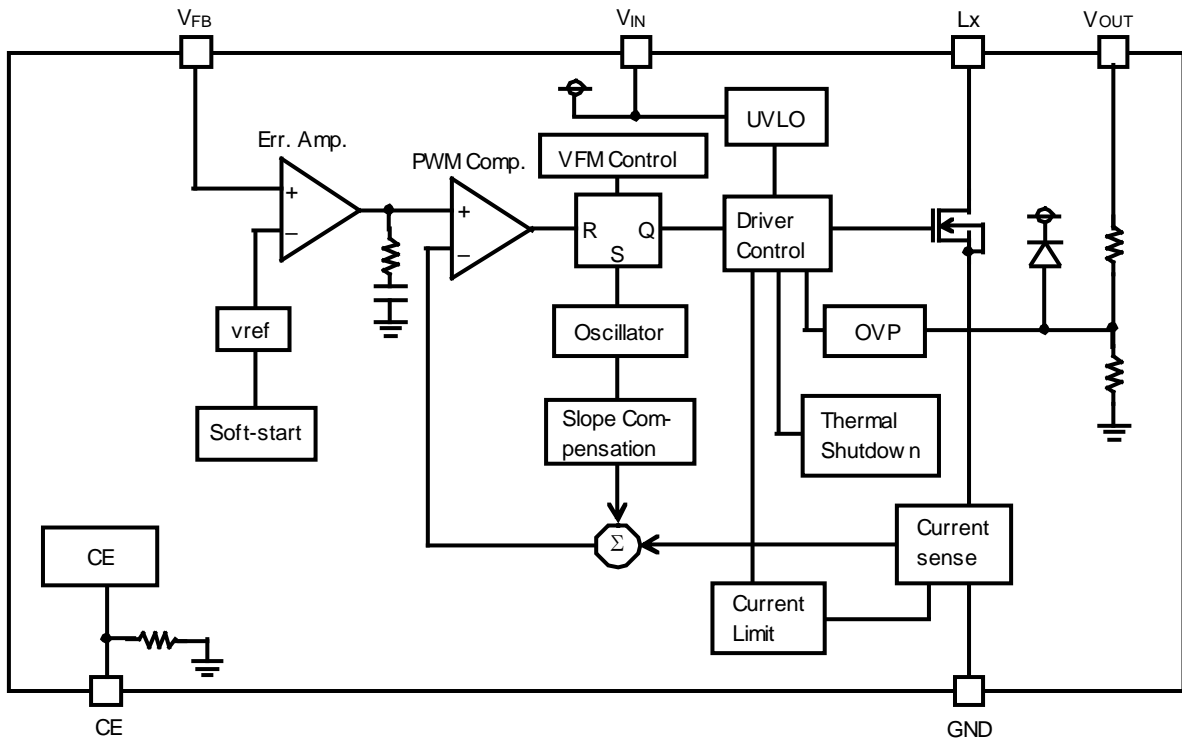
**R1204xxxxC/F Block Diagram**

PIN DESCRIPTIONS

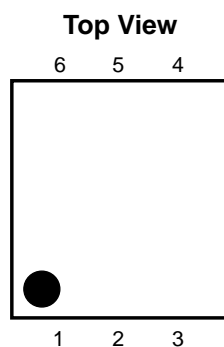

DFN(PLP)1820-6 Pin Configuration

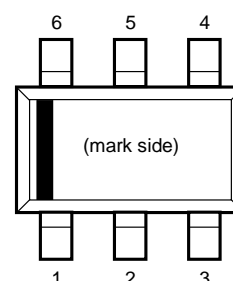
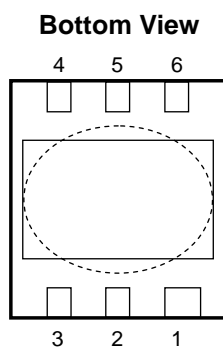

TSOT-23-6 Pin Configuration

DFN(PLP)1820-6 Pin Description

Pin No	Symbol	Description
1	V_{OUT}	Output Pin
2	L_X	Switching Pin, Open Drain Output
3	GND	Ground Pin
4	V_{IN}	Input Pin
5	CE	Chip Enable Pin, Active-high
6	V_{FB}	Feedback Pin

The exposed tab is substrate level (GND). It is recommended that the exposed tab be connected to the ground plane on the board or otherwise be left open.

TSOT-23-6 Pin Description

Pin No	Symbol	Description
1	L_X	Switching Pin, Open Drain Output
2	GND	Ground Pin
3	V_{FB}	Feedback Pin
4	CE	Chip Enable Pin, Active-high
5	V_{OUT}	Output Pin
6	V_{IN}	Input Pin

R1204x

No. EA-284-200901

ABSOLUTE MAXIMUM RATINGS

Absolute Maximum Ratings

(GND = 0 V)

Symbol	Parameter		Rating	Unit	
V_{IN}	V_{IN} Pin Voltage		-0.3 to 6.5	V	
V_{CE}	CE Pin Voltage		-0.3 to 6.5	V	
V_{FB}	V_{FB} Pin Voltage		-0.3 to 6.5	V	
V_{OUT}	V_{OUT} Pin Voltage		-0.3 to 48	V	
V_{LX}	L_X Pin Voltage		-0.3 to 48	V	
I_{LX}	L_X Pin Current		1200	mA	
P_D	Power Dissipation ⁽¹⁾	DFN(PLP)1820-6	JEDEC STD. 51-7	2200	mW
		TSOT-23-6	Standard Test Land Pattern	460	
T_j	Junction Temperature Range		-40 to 125	°C	
T_{stg}	Storage Temperature Range		-55 to 125	°C	

ABSOLUTE MAXIMUM RATINGS

Electronic and mechanical stress momentarily exceeded absolute maximum ratings may cause permanent damage and may degrade the lifetime and safety for both device and system using the device in the field. The functional operation at or over these absolute maximum ratings is not assured.

RECOMMENDED OPERATING CONDITIONS

Recommended Operating Conditions

Symbol	Parameter	Rating	Unit
V_{IN}	Input Voltage	2.3 to 5.5	V
T_a	Operating Temperature Range	-40 to 85	°C

RECOMMENDED OPERATING CONDITIONS

All of electronic equipment should be designed that the mounted semiconductor devices operate within the recommended operating conditions. The semiconductor devices cannot operate normally over the recommended operating conditions, even if they are used over such ratings by momentary electronic noise or surge. And the semiconductor devices may receive serious damage when they continue to operate over the recommended operating conditions.

⁽¹⁾ Refer to *POWER DISSIPATION* for detailed information.

ELECTRICAL CHARACTERISTICS

R1204xxxxx Electrical Characteristics

(Ta = 25°C)

Symbol	Parameter	Test Conditions/Comments	Min.	Typ.	Max.	Unit	
I _{DD}	Supply Current	V _{IN} = 5.5 V, V _{FB} = 0 V, L _X at no load		0.8		mA	
I _{standby}	Standby Current	V _{IN} = 5.5 V, V _{CE} = 0 V		1.0	5.0	μA	
V _{UVLO1}	UVLO Detector Threshold	V _{IN} falling	1.9	2.0	2.1	V	
V _{UVLO2}	UVLO Released Voltage	V _{IN} rising		V _{UVLO1} +0.1		V	
V _{CEH}	CE Input Voltage "H"	V _{IN} = 5.5 V	1.5			V	
V _{CEL}	CE Input Voltage "L"	V _{IN} = 2.3 V			0.5	V	
R _{CE}	CE Pull Down Resistance	V _{IN} = 3.6 V		R1204xxxxA/B/D/E/G/H 1200 R1204xxxxC/F 600		kΩ	
V _{FB}	V _{FB} Voltage Accuracy	V _{IN} = 3.6 V		R1204xxxxA/D 0.19 R1204xxxxG/H 0.39 R1204xxxxB/C/E/F 0.985	0.2 0.4 1.000	0.21 0.41 1.015	V
I _{FB}	V _{FB} Input Current	V _{IN} = 5.5 V, V _{FB} = 0 V or 5.5 V	-0.1		0.1	μA	
T _{start}	Soft-start Time	V _{IN} = 3.6 V, R1204xxxxB/C/E/F		10		ms	
R _{ON}	FET ON Resistance	V _{IN} = 3.6 V, I _{LX} = 100 mA		0.8		Ω	
I _{LXLEAK}	FET Leakage Current	V _{LX} = 40 V			3.0	μA	
I _{LXLIM}	FET Current Limit	V _{IN} = 3.6 V	700	900	1100	mA	
f _{osc}	Oscillator Frequency	V _{IN} = 3.6 V, V _{FB} = 0 V		R1204xxxxA/B/C/G 0.9 R1204xxxxD/E/F/H 675	1.0 750	1.1 825	MHz kHz
Maxduty	Oscillator Maximum Duty Cycle	V _{IN} = 3.6 V, V _{FB} = 0 V		R1204xxxxA/B/C/G 91 R1204xxxxD/E/F/H 92			% %
V _{OVP1}	OVP Detector Threshold	V _{IN} = 3.6 V, V _{OUT} rising		R1204x1xxx 22.0 R1204x2xxx 31.5 R1204x3xxx 40.2	23 33 42	24.0 34.5 43.8	V
V _{OVP2}	OVP Released Voltage	V _{IN} = 3.6 V, V _{OUT} falling		R1204x1xxx R1204x2xxx R1204x3xxx	V _{OVP1} -0.6 V _{OVP1} -1.2 V _{OVP1} -2.4		V
T _{TSD}	Thermal Shutdown Temperature	V _{IN} = 3.6 V		150		°C	
T _{TSR}	Thermal Shutdown Released Temperature	V _{IN} = 3.6 V		100		°C	

All test items listed under Electrical Characteristics are done under the pulse load condition (T_j ≈ Ta = 25°C).

THEORY OF OPERATION

Operation of Step-Up DC/DC Converter and Output Current

<Basic Circuit>

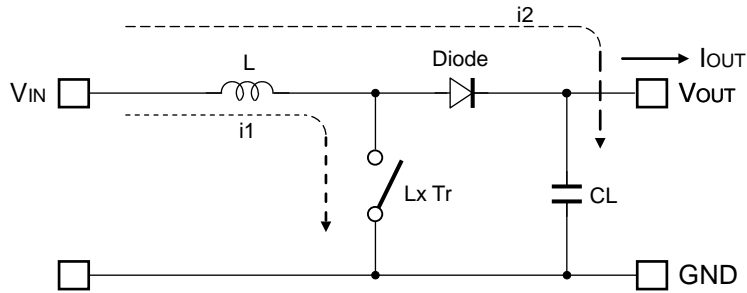

<Current through L>

Discontinuous mode

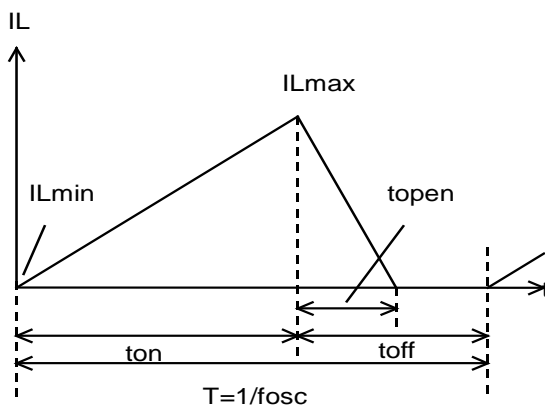

Continuous mode

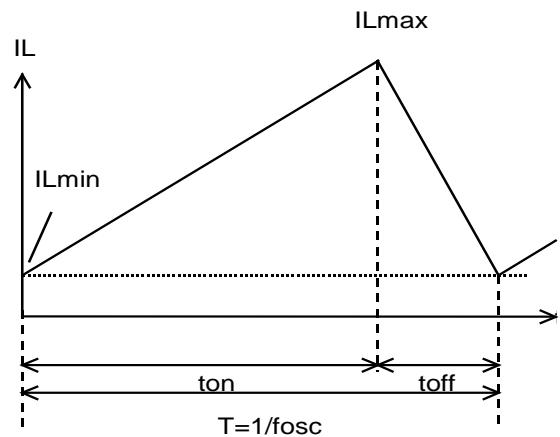

There are two operation modes of the step-up PWM control-DC/DC converter. That is the continuous mode and discontinuous mode by the continuousness inductor.

When the transistor turns ON, the voltage of inductor L becomes equal to V_{IN} voltage. The increase value of inductor current (i1) will be

$\Delta i1 = V_{IN} \times ton / L$ Formula 1

As the step-up circuit, during the OFF time (when the transistor turns OFF) the voltage is continually supply from the power supply. The decrease value of inductor current (i2) will be

$\Delta i2 = (V_{OUT} - V_{IN}) \times topen / L$ Formula 2

At the PWM control-method, the inductor current become continuously when $t_{open} = t_{off}$, the DC/DC converter operate as the continuous mode.

In the continuous mode, the variation of current of i_1 and i_2 is same at regular condition.

$$V_{IN} \times t_{on} / L = (V_{OUT} - V_{IN}) \times t_{off} / L \dots\dots\dots \text{Formula 3}$$

The duty at continuous mode will be

$$\text{duty (\%)} = t_{on} / (t_{on} + t_{off}) = (V_{OUT} - V_{IN}) / V_{OUT} \dots\dots\dots \text{Formula 4}$$

The average of inductor current at $t_f = t_{off}$ will be

$$I_L (\text{Ave.}) = V_{IN} \times t_{on} / (2 \times L) \dots\dots\dots \text{Formula 5}$$

If the input voltage = output voltage, the I_{OUT} will be

$$I_{OUT} = V_{IN2} \times t_{on} / (2 \times L \times V_{OUT}) \dots\dots\dots \text{Formula 6}$$

If the I_{OUT} value is large than above the calculated value (Formula 6), it will become the continuous mode, at this status, the peak current (I_{LMAX}) of inductor will be

$$I_{LMAX} = I_{OUT} \times V_{OUT} / V_{IN} + V_{IN} \times t_{on} / (2 \times L) \dots\dots\dots \text{Formula 7}$$

$$I_{LMAX} = I_{OUT} \times V_{OUT} / V_{IN} + V_{IN} \times T \times (V_{OUT} - V_{IN}) / (2 \times L \times V_{OUT}) \dots\dots\dots \text{Formula 8}$$

The peak current value is larger than the I_{OUT} value. In case of this, selecting the condition of the input and the output and the external components by considering of I_{LMAX} value.

The explanation above is based on the ideal calculation, and the loss caused by LX switch and the external components are not included.

The actual maximum output current will be between 50% and 80% by the above calculations. Especially, when the I_L is large or V_{IN} is low, the loss of V_{IN} is generated with on resistance of the switch. Moreover, it is necessary to consider V_f of the diode (approximately 0.8 V) about V_{OUT} .

R1204x

No. EA-284-200901

PWM/VFM Auto-Switching Control (R1204xxxxC/F)

In low output current, the IC automatically switches to high-efficiency VFM mode. The minimum Onduty (D_{ON_MIN}) of VFM mode is set to approximately 30% and is fixed inside the IC. If the difference between the voltages of the input and the output is small, or the Onduty in continuous mode (D_{ON_CON}) becomes lower than D_{ON_MIN} , the IC will not shift to PWM mode but will stay with VFM mode instead even in high output current, as a result, the ripple current will be increased. D_{ON_MIN} should be 70% or more ($V_{SET} > V_{IN} \times 3.33$).

Soft-Start Function (R1204xxxxA/D/G/H)

Unless otherwise V_{OUT} is beyond the threshold ($V_f \times$ number of LED lights), current will not flow through LEDs, as a result, V_{FB} voltage will not increase. The IC increases V_{OUT} by controlling the output of error amplifier to "H" and turning the L_x switch on and off for a certain period of time (until the current flow). At the mean time, the inrush current is controlled by gradually increasing the current limit. If V_{OUT} is over the threshold (the current flows), the IC controls the soft-start function by gradually increasing the reference voltage of error amplifier.

(R1204xxxxB/C/E/F)

The IC controls the soft-start function by gradually increasing the reference voltage of error amplifier. Soft-start begins when the output voltage of error amplifier is 0V and ends when it reaches the constant voltage.

Current Limit Function

If the peak current of inductor (I_{LMAX}) exceeds the current limit, current limit function turns the driver off and turns it on in every switching cycle to continually monitor the driver current.

Under Voltage Lock Out Function (UVLO)

UVLO function stops DC/DC operation and prevents malfunction when the supply voltage falls below the UVLO detector threshold.

Over Voltage Protection Circuit (OVP)

OVP circuit monitors the V_{OUT} pin voltage and if it reaches the OVP voltage it will stop oscillation. When the V_{OUT} pin voltage decreases it will restart oscillation, but if the cause of the excess V_{OUT} pin voltage is not removed the OVP circuit will operate repeatedly so as to restrict the V_{OUT} pin voltage.

Thermal Shutdown Function

If the junction temperature exceeds the thermal shutdown temperature, thermal shutdown function turns the driver off. If the junction temperature becomes lower than the thermal shutdown released temperature, the thermal shutdown function resets the IC to restart the operation.

APPLICATION INFORMATION

R1204xxxxA/D/G/H Typical Applications

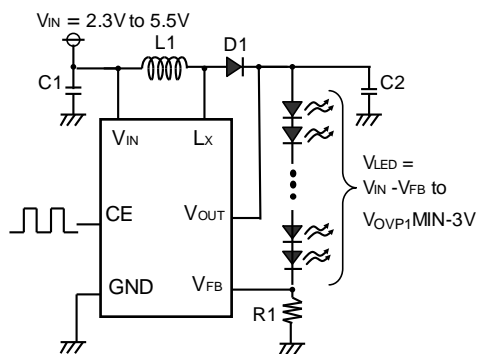

Figure 1.

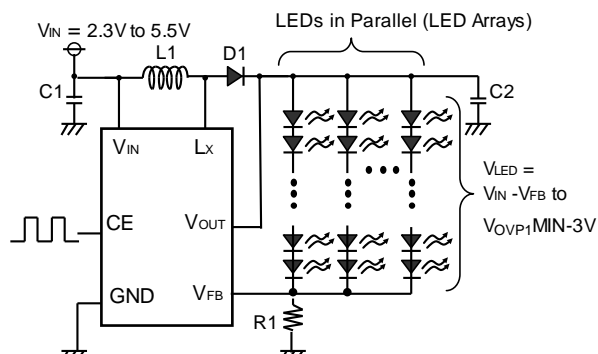

Figure 2.

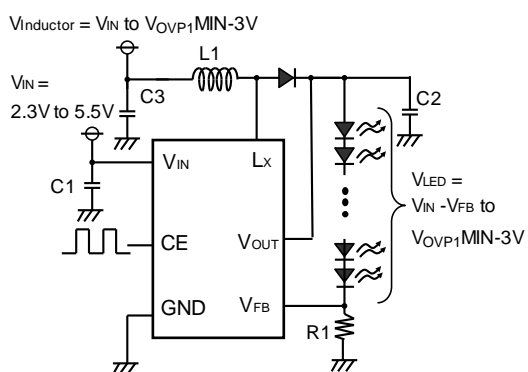

Figure 3.

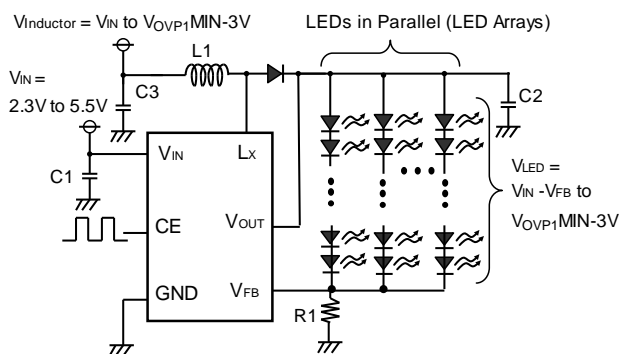

Figure 4.

R1204xxxxB/C/E/F Typical Applications

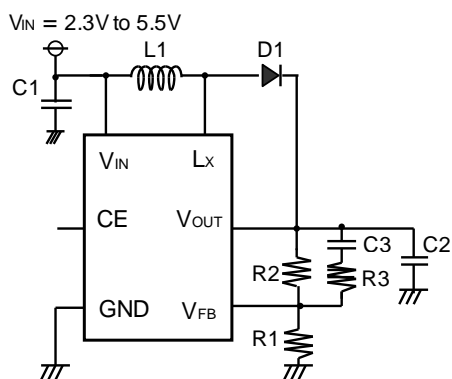

Figure 5.

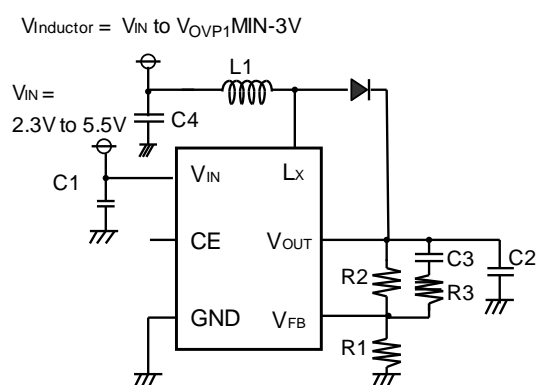

Figure 6.

R1204x

No. EA-284-200901

Selection of Inductor

Peak current of inductor (I_{LMAX}) in normal mode when the efficiency is 80% can be calculated by the following formula.

$$I_{LMAX} = 1.25 \times I_{OUT} \times V_{OUT} / V_{IN} + 0.5 \times V_{IN} \times (V_{OUT} - V_{IN}) / (L1 \times V_{OUT} \times f_{osc})$$

- When starting up the IC or when adjusting the brightness of LEDs, a large transient current may flow into an inductor (L1).
- I_{LMAX} should be equal or smaller than the current limit of the IC.
- When deciding the rated current of inductor, I_{LMAX} should be considered.
- It is recommended that L1 with 10 μ H to 22 μ H be used.

Table 1. Peak Current Values for V_{IN} , V_{OUT} , I_{OUT} , and L1

V_{IN} (V)	V_{OUT} (V)	I_{OUT} (mA)	L1 (μ H)	I_{LMAX} (mA)
3	21	20	10	280
3	21	20	22	225
3	30	20	10	365
3	30	20	22	305

Table 2. Recommended Inductors

L1 (μ H)	Parts No.	Rated Current (mA)	Size (mm)	Versions
10	VLS252010ET-100M	550	2.5 × 2.0 × 1.0	R1204xxxxA/B/C/G
10	VLF302512MT-100M	620	3.0 × 2.5 × 1.2	
10	VLF403212MT-100M	900	4.0 × 3.2 × 1.2	
22	VLF302512MT-220M	430	3.0 × 2.5 × 1.2	R1204xxxxD/E/F/H
22	VLF403212MT-220M	540	4.0 × 3.2 × 1.2	
22	VLF504012MT-220M	800	5.0 × 4.0 × 1.2	

Selection of Capacitor

- Place a 1 μ F or more bypass capacitor (C1) as close as possible to the V_{IN} and GND pins

[R1204xxxxA/D/G/H]

- Place a 1 μ F or more output capacitor (C2) as close as possible to the V_{OUT} and GND pins.
- In the case of operating the inductor using a separated power supply from the IC, place a 1 μ F or more bypass capacitor (C3) as close as possible to $V_{inductor}$ and the GND pin.
- Note the V_{OUT} that depends on LED used, and select the rating of V_{OUT} or more.

[R1204xxxxB/C/E/F]

- Place 1 μ F to 10 μ F C2 as close as possible to the V_{OUT} and GND pins.
- In the case of operating the inductor using a separated power supply from the IC, place a 1 μ F or more bypass capacitor (C4) as close as possible to $V_{inductor}$ and the GND pin.

SBD (Schottky Barrier Diode) Selection

- Choose a diode that has low V_F , low reverse current I_R , and low capacitance.
- SBD is an ideal type of diode for R1204x since it has low V_F , low reverse current I_R , and low capacitance.

Table 3. Recommended Components for R1204xxxxA/D/G/H

Symbol	Rated Voltage (V)	Parts No.
D1	60	CRS12
C1	6.3	CM105B105K06
C2	50	C2012X5R1H105K
		C2012X5R1H225K (R1204xxxxG/H: $I_{LED} > 22$ mA)
C3 (Option: Figure 4)	Select by the input voltage	1 μ F or more

Table 4. Recommended Components for R1204xxxxB/C/E/F

Symbol	Rated Voltage (V)	Parts No.
D1	60	CRS12
C1	6.3	CM105B105K06
C2	16	C2012X5R1C475K
	25	C2012X5R1E105K
	50	C2012X5R1H105K
C4 (Option: Figure 6)	Select by the input voltage	1 μ F or more

Table 5. Recommended Component Values for R1204xxxxB/C/E/F

V_{SET} (V)	$7 < V_{SET} \leq 10$	$10 < V_{SET} \leq 25$	$25 < V_{SET}$
R1 (k Ω)	10	10	10
R2 (k Ω)	$(V_{SET} - 1) \times R1$	$(V_{SET} - 1) \times R1$	$(V_{SET} - 1) \times R1$
R3 (Ω)	0	0	0
C1 (μ F)	1.0	1.0	1.0
C2 (μ F)	4.7	1.0×2	1.0
C3 (pF)	10	10	10
C4 (μ F)	1.0	1.0	1.0

R1204x

No. EA-284-200901

Other External Components Settings

Set a capacitor (C3) between the V_{OUT} and V_{FB} pins to improve the response of DC/DC converter by giving high-frequency voltage feedback. Please note that C3 operation could be different from the theory of operation depending on component layouts and parasitic capacitances.

Output Voltage Setting (R1204xxxxB/C/E/F)

The relation between the output voltage (V_{SET}) and the resistors (R1, R2) is calculable by the following formula.

$$V_{SET} = V_{FB} \times (R1 + R2) / R1$$

The sum of R1 and R2 should be 300 kΩ or less. Ensure the V_{IN} and GND lines are sufficiently robust. If their impedances are too high, noise pickup or unstable operation may result. Set a capacitor (C2) with a suitable voltage resistance (more than 1.5 times of V_{SET}) between the V_{IN} and GND pins, and as close as possible to the pins.

LED Current Setting (R1204xxxxA/D/G/H)

The LED current (I_{LED}) when a "H" signal is applied to the CE pin (Duty = 100%) can be determined by the value of feedback resistor (R1).

$$I_{LED} = 0.2 / R1 \text{ (R1204xxxxA/D)}$$

$$I_{LED} = 0.4 / R1 \text{ (R1204xxxxG/H)}$$

LED Dimming Control (R1204xxxxA/D/G/H)

The brightness of the LEDs can be adjusted by applying a PWM signal to the CE pin. By inputting "L" voltage for a certain period of time (Typ. 9 ms (R1204xxxxA/G) / 12 ms (R1204xxxxD/H) or more), the IC goes into standby mode and turns off LEDs. I_{LED} can be controlled by the duty of a PWM signal for the CE pin.

The relation between the high-duty of the CE pin (Hduty) and I_{LED} is calculable by the following formula.

$$I_{LED} = Hduty \times V_{FB} / R1$$

The frequency range of a PWM signal should be set within the range of 200 Hz to 300 kHz. In the case of using a 20 kHz or less PWM signal for dimming the LEDs, the increasing or decreasing of the inductor current (IL) may make noise in the audible band. In this case, a high frequency PWM signal should be used.

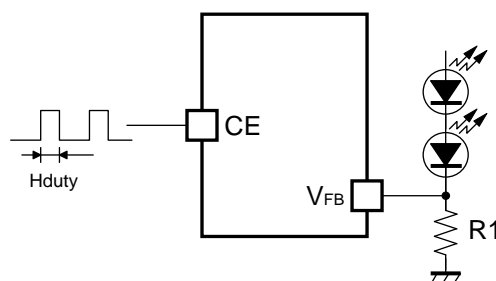

Figure 7. Dimming Control by CE Pin

Low luminance Dimming Accuracy (R1204xxxxG/H)

Low luminance Dimming filtered V_{FB} voltage tolerance depends on the offset voltage of the internal DC/DC converter. By this offset voltage, some voltage difference may be generated between V_{REF} voltage and V_{FB} voltage. Low luminance Dimming Accuracy is shown in Table 5.

Table 6. Low luminance Dimming Accuracy for R1204xxxxG/H ($R1 = 20 \Omega$)

The duty of a PWM signal for the CE pin	I_{LED} Min.	I_{LED} Max.
3.5% (Frequency = 20 kHz to 300 kHz)	0.01 mA ⁽²⁾	2.1 mA ⁽²⁾

⁽²⁾ Guaranteed by design engineering ($T_a = 25^\circ\text{C}$).

TECHNICAL NOTES

Current Path on PCB

Figure 8 and Figure 9 show flows of current paths of the application circuits when MOSFET is ON and when MOSFET is OFF, respectively.

- Parasitic elements (impedance, inductance or capacitance) in the paths pointed with red arrows in Figure 8 and Figure 9 influence stability of the system and cause noise outbreak. It is recommended that these parasitic elements be minimized.
- In addition, except for the paths of LED load, it is recommended that the all wirings of the current paths be made as short and wide as possible.

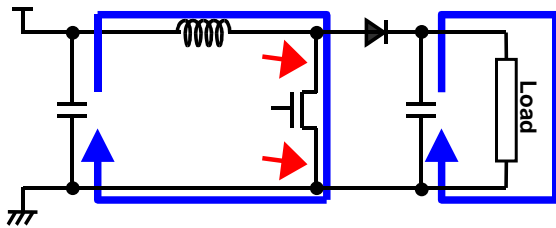

Figure 8. MOSFET-ON

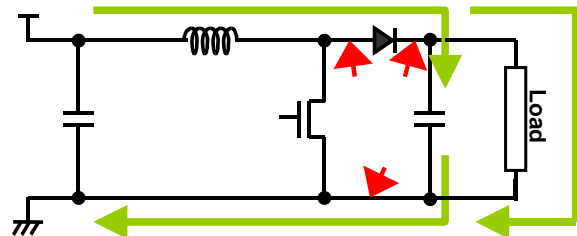

Figure 9. MOSFET-OFF

Layout Guide for PCB

- Place C1 as close as possible to the V_{IN} and GND pins. Also, connect the GND pin to the wider GND plane.
- Make the L_X land pattern as small as possible.
- Make the wirings between the L_X pin, the inductor and the diode as short as possible. Also, connect C2 as close as possible to the cathode of the diode.
- Place C2 as close as possible to the GND pin.

PCB Layout

PKG: DFN(PLP)1820-6 pin

R1204Kxx2A/D/G/H

Topside

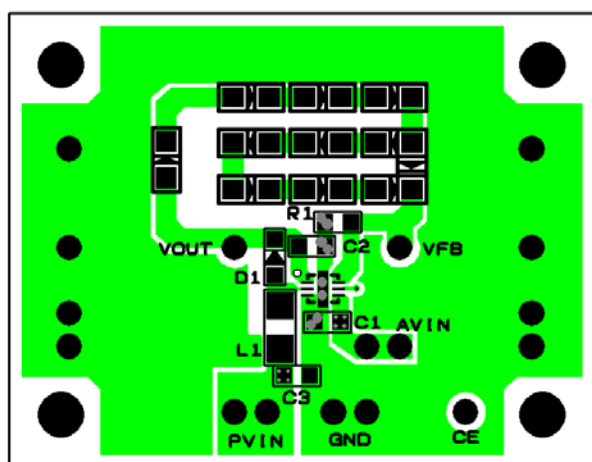

Backside

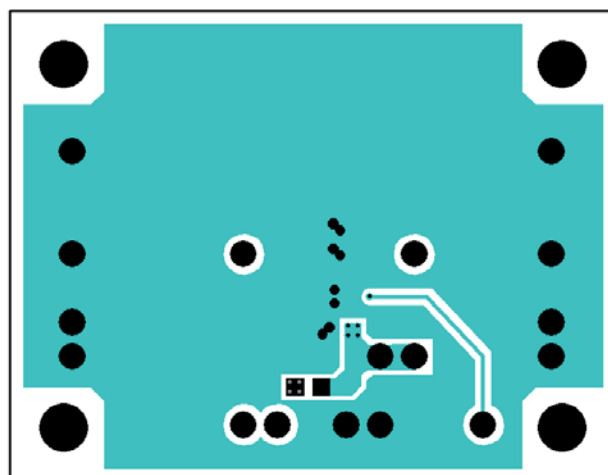

R1204Kxx2B/C/E/F

Topside

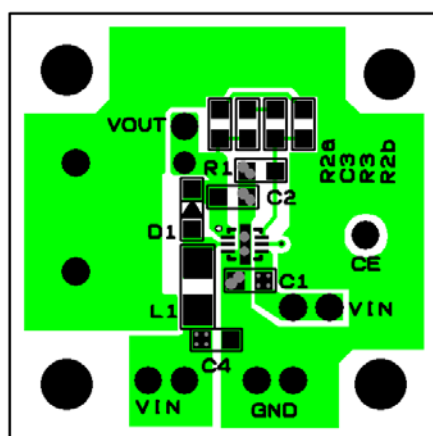

Backside

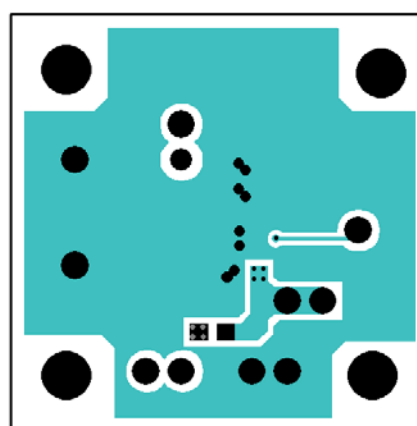

R1204x

No. EA-284-200901

PKG: TSOT-23-6 pin

R1204Nxx3A/D/G/H

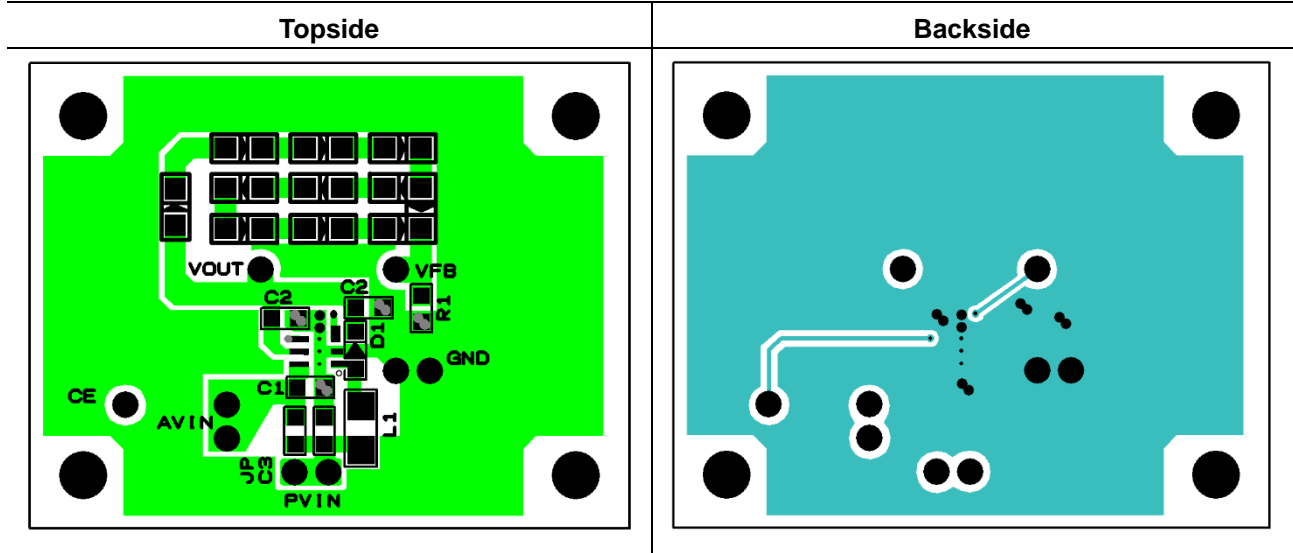

R1204Nxx3B/C/E/F

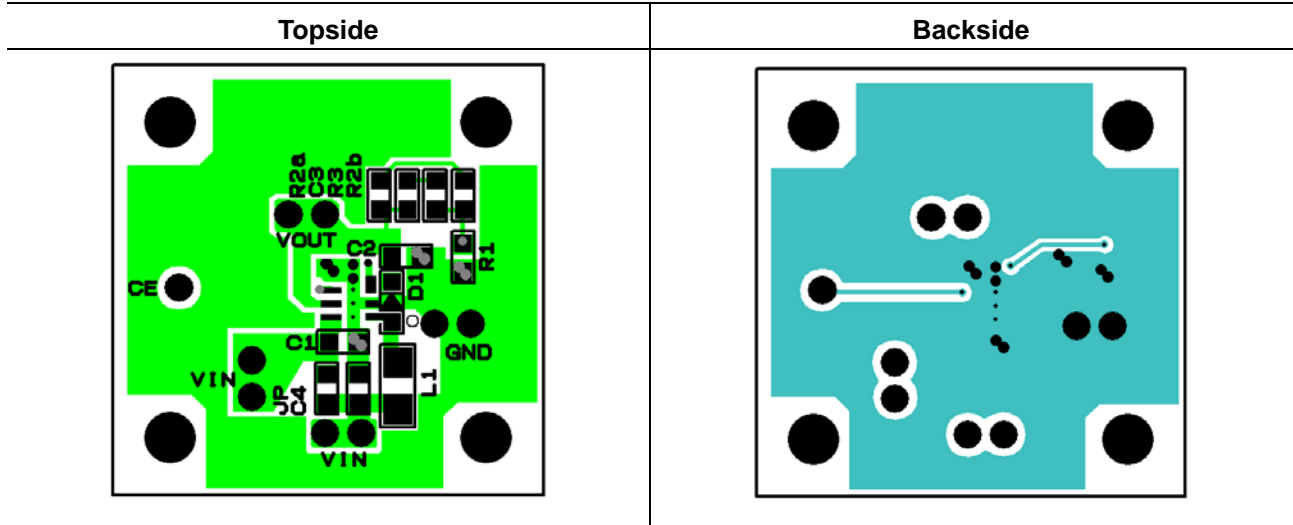

TYPICAL CHARACTERISTICS

1) Efficiency vs. Output Current of R1204xxxxA/D/G/H
Used LED: NICHIA, NSSW208A ($V_f = 3.0\text{ V}$ ($I_{LED} = 20\text{ mA}$))

1-1) Efficiency vs. Output Current with Different Output Voltages, 10 LEDs in Series ($V_{OUT} = 30\text{ V}$ ($I_{OUT} = 20\text{ mA}$))

R1204xxxxA/G, $L = 10\text{ }\mu\text{H}$ (VLF302512MT-100M)

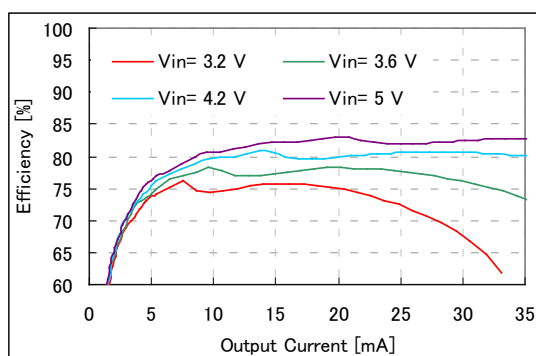

R1204xxxxD/H, $L = 22\text{ }\mu\text{H}$ (VLF302512MT-220M)

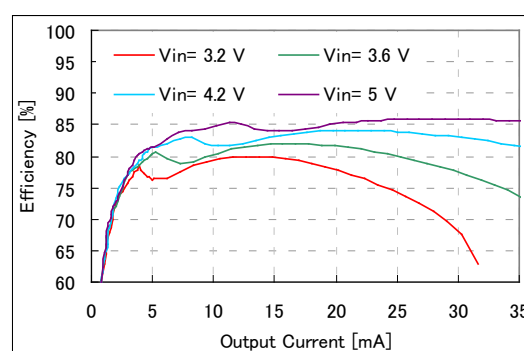

8 LEDs in Series ($V_{OUT} = 24\text{ V}$ ($I_{OUT} = 20\text{ mA}$))

R1204xxxxA/G, $L = 10\text{ }\mu\text{H}$ (VLF302512MT-100M)

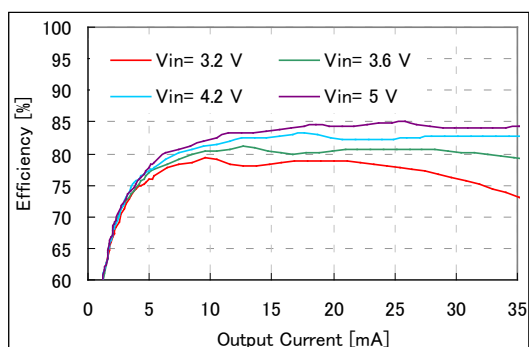

R1204xxxxD/H, $L = 22\text{ }\mu\text{H}$ (VLF302512MT-220M)

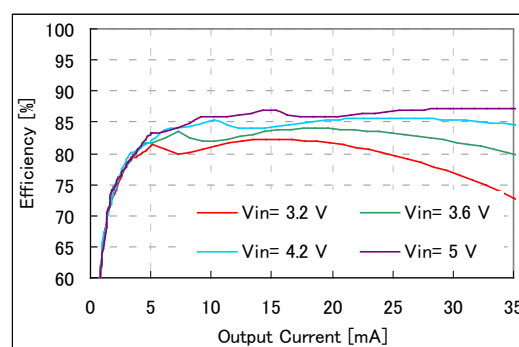

6 LEDs in Series ($V_{OUT} = 18\text{ V}$ ($I_{OUT} = 20\text{ mA}$))

R1204xxxxA/G, $L = 10\text{ }\mu\text{H}$ (VLF302512MT-100M)

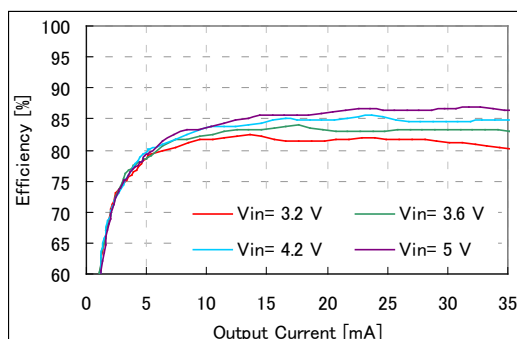

R1204xxxxD/H, $L = 22\text{ }\mu\text{H}$ (VLF302512MT-220M)

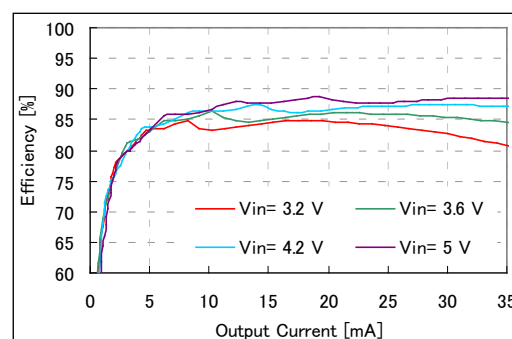

R1204x

No. EA-284-200901

1-2) Efficiency vs. Output Current with Different Inductors ($V_{IN} = 3.6\text{ V}$)

10 LEDs in Series ($V_{OUT} = 30\text{ V}$ ($I_{OUT} = 20\text{ mA}$))

R1204xxxxA/G

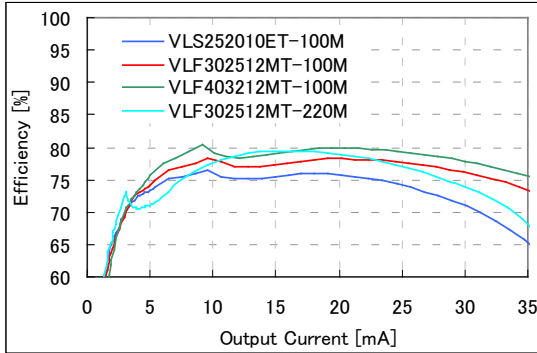

R1204xxxxD/H

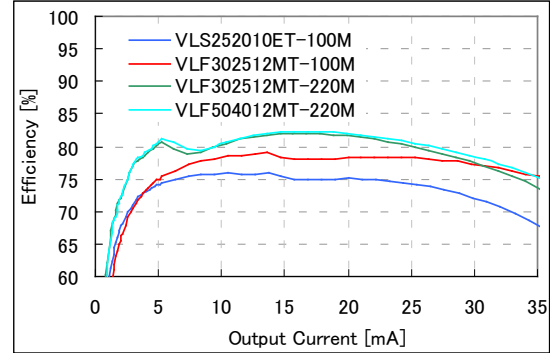

8 LEDs in Series ($V_{OUT} = 24\text{ V}$ ($I_{OUT} = 20\text{ mA}$))

R1204xxxxA/G

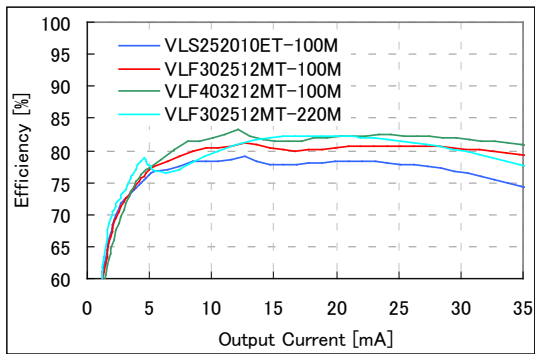

R1204xxxxD/H

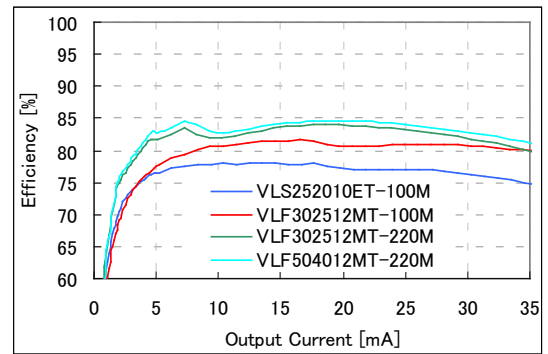

1-3) Efficiency vs. Output Current with Different Numbers of LEDs

LEDs in 3 Parallels ($V_{IN} = 3.6\text{ V}$)

R1204xxxxA/G, $L=10\mu\text{H}$ (VLF302512MT-100M)

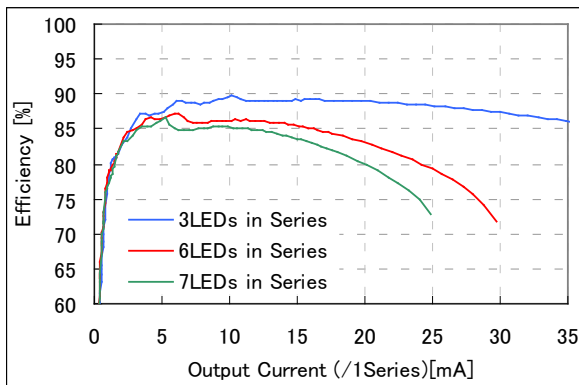

R1204xxxxD/H, $L=22\mu\text{H}$ (VLF302512MT-220M)

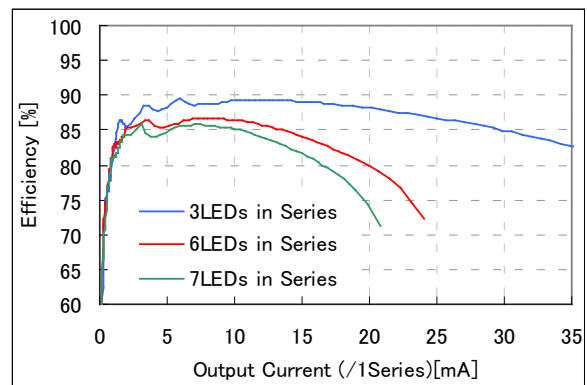

LEDs in 3 Parallels ($V_{IN} = 5.0\text{ V}$)

R1204xxxxA/G, $L = 10\ \mu\text{H}$ (VLF302512MT-100M)

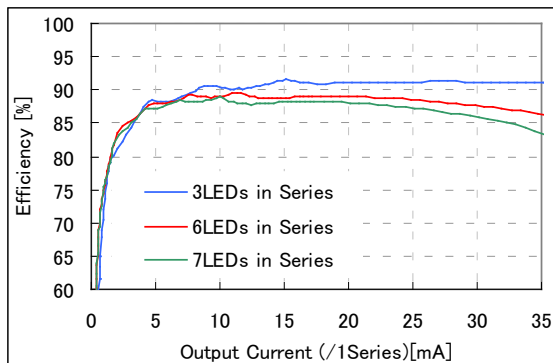

R1204xxxxD/H, $L = 22\ \mu\text{H}$ (VLF302512MT-220M)

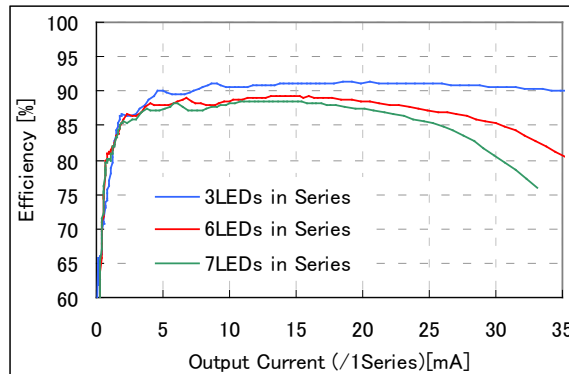

1-4) Efficiency vs. Output Current with Different Numbers of LEDs

LEDs in 3 Parallels ($V_{IN} = 3.6\text{ V}$, Inductor Voltage = 12.0 V)

R1204xxxxA/G, $L = 10\ \mu\text{H}$ (VLF302512MT-100M)

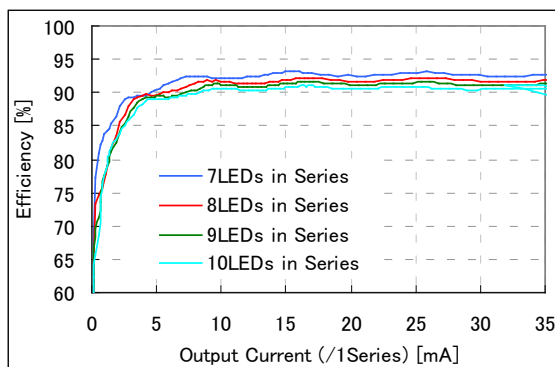

R1204xxxxD/H, $L = 22\ \mu\text{H}$ (VLF302512MT-220M)

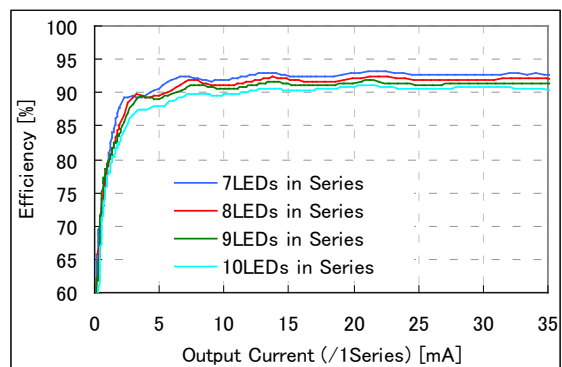

LEDs in 6 Parallels ($V_{IN} = 3.6\text{ V}$, Inductor Voltage = 12.0 V)

R1204xxxxA/G, $L = 10\ \mu\text{H}$ (VLF302512MT-100M)

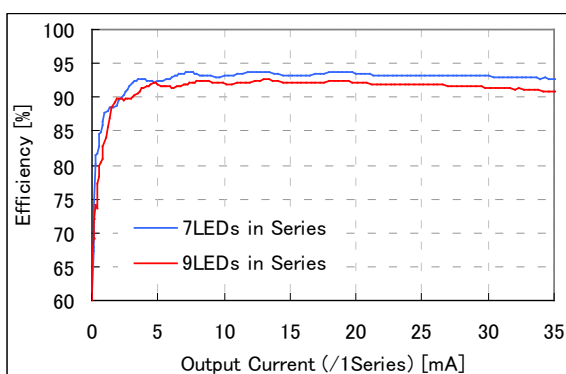

R1204xxxxD/H, $L = 22\ \mu\text{H}$ (VLF302512MT-220M)

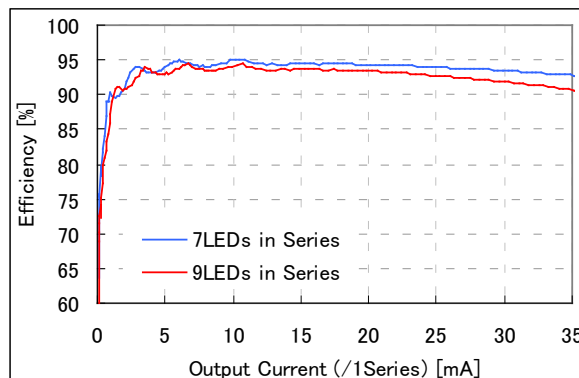

R1204x

No. EA-284-200901

2) Efficiency vs. Output Current of R1204xxxxB/C/E/F

2-1) Efficiency vs. Output Current with Different Output Voltages

$V_{SET} = 31\text{ V}$

$V_{IN} = \text{Inductor Voltages}$

R1204xxxxC, L = 10 μH (VLF302512MT-100M)

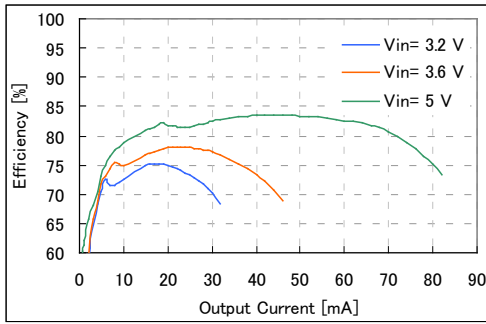

R1204xxxxF, L = 22 μH (VLF302512MT-220M)

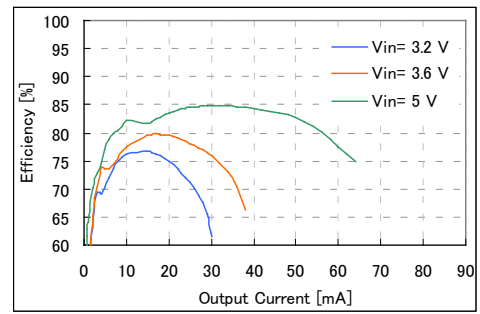

Different V_{IN} / Inductor Voltages ($V_{IN} = 3.6\text{ V}$)

R1204xxxxC, L = 10 μH (VLF302512MT-100M)

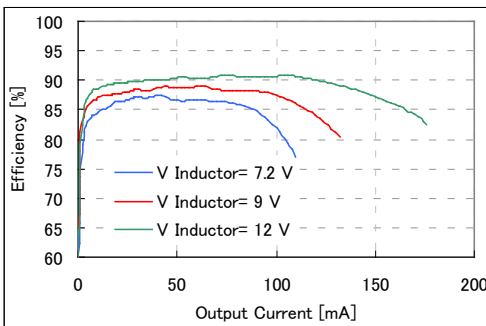

R1204xxxxF, L = 22 μH (VLF302512MT-220M)

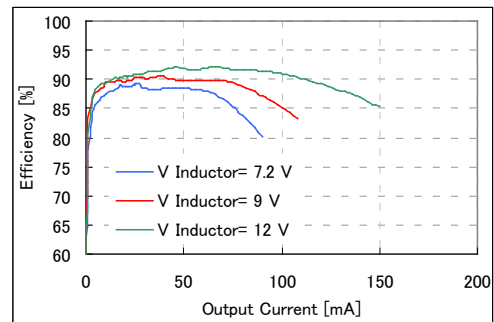

$V_{SET} = 25\text{ V}$

$V_{IN} = \text{Inductor Voltages}$

R1204xxxxC, L = 10 μH (VLF302512MT-100M)

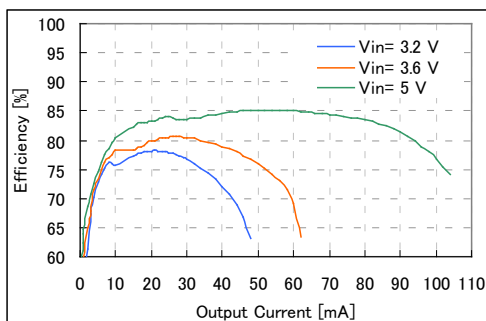

R1204xxxxF, L = 22 μH (VLF302512MT-220M)

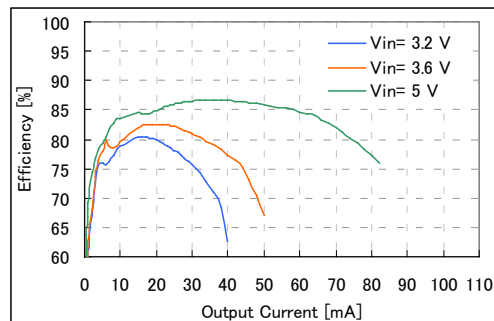

Different V_{IN} / Inductor Voltages ($V_{IN} = 3.6\text{ V}$)

R1204xxxxC, L = 10 μH (VLF302512MT-100M)

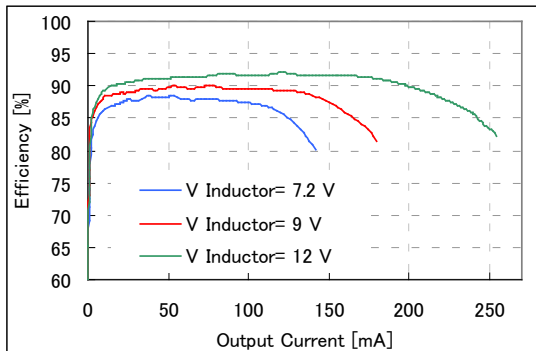

R1204xxxxF, L = 22 μH (VLF302512MT-220M)

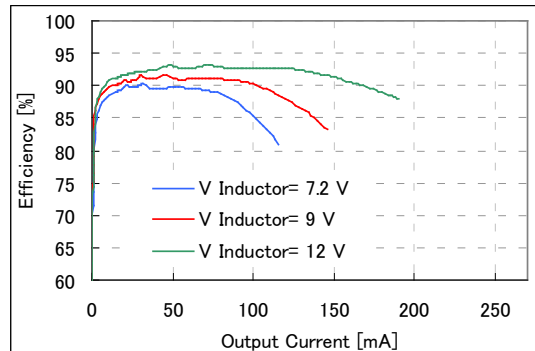

$V_{SET} = 21\text{ V}$

$V_{IN} = \text{Inductor Voltage}$

R1204xxxxC, L = 10 μH (VLF302512MT-100M)

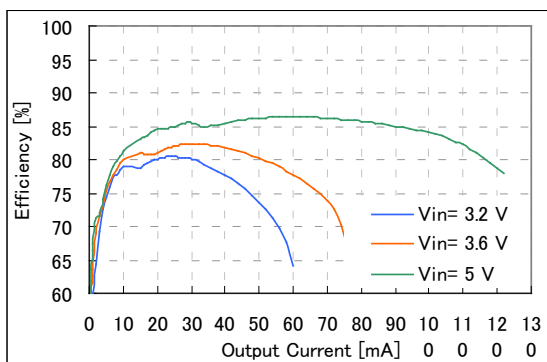

R1204xxxxF, L = 22 μH (VLF302512MT-220M)

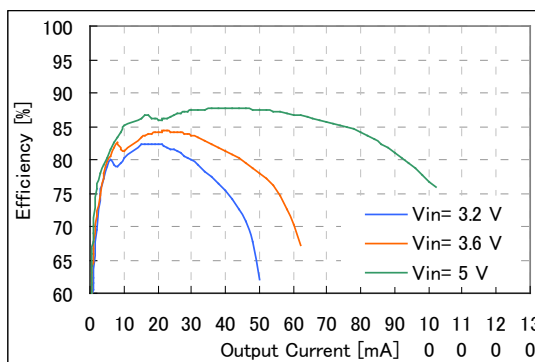

Different V_{IN} / Inductor Voltages ($V_{IN} = 3.6\text{ V}$)

R1204xxxxC, L = 10 μH (VLF302512MT-100M)

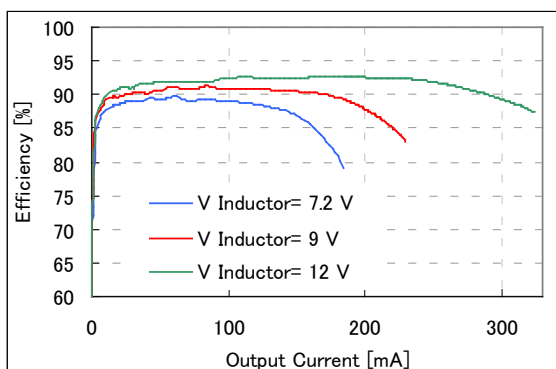

R1204xxxxF, L = 22 μH (VLF302512MT-220M)

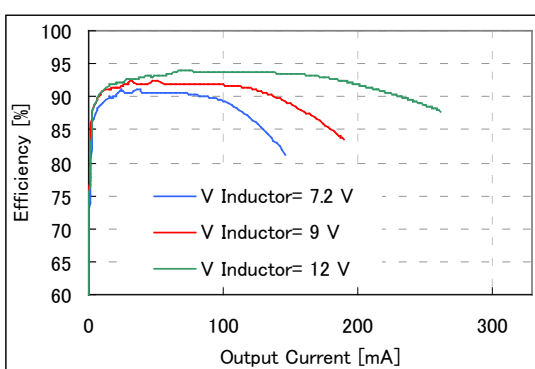

R1204x

No. EA-284-200901

2-2) Efficiency vs. Output Current with PWM Control and PWM/VFM Auto-Switching Control

($V_{IN} = 3.6\text{ V}$, $V_{SET} = 12\text{ V}$)

R1204xxxxB/C, L = 10 μH (VLF302512MT-100M)

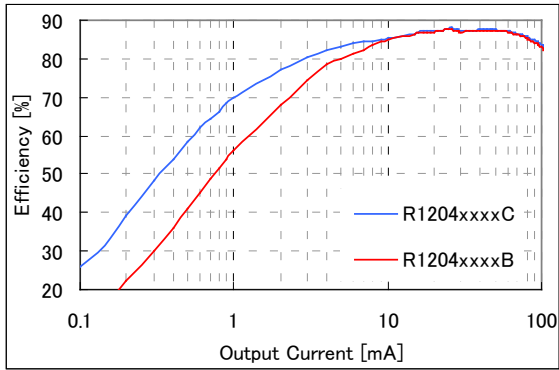

R1204xxxxE/F, L = 22 μH (VLF302512MT-220M)

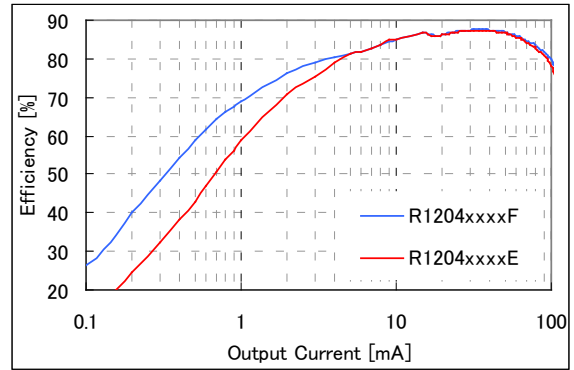

Inductor Voltage = 7.2 V, $V_{SET} = 25\text{ V}$

R1204xxxxB/C, L = 10 μH (VLF302512MT-100M)

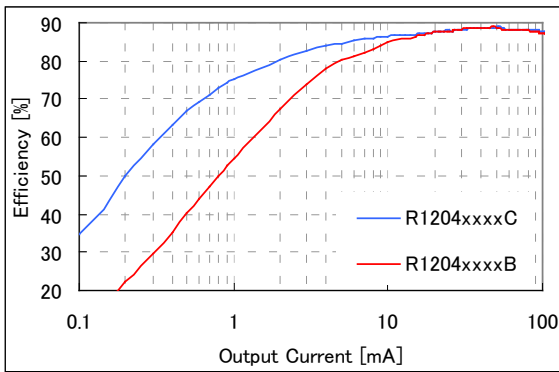

3) Maxduty vs. I_{LED} (R1204xxxxA/D/G/H, 10 LEDs in Series, $V_{IN} = 3.6\text{ V}$)

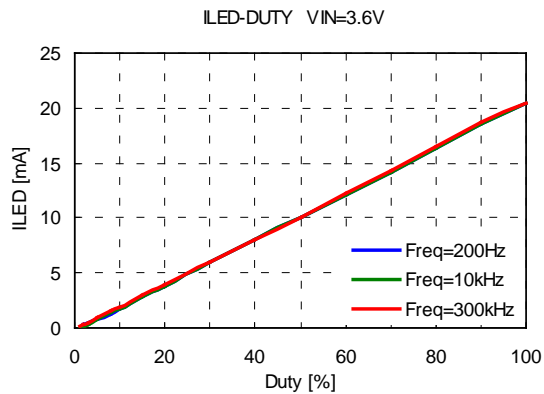

4) V_{OUT} / I_{LED} Ripple of R1204xxxxA/D/G/H When Dimming (10 LEDs in Series, $L = 10 \mu\text{H}$ (VLF302512MT-100M))

CE Freq = 200 Hz

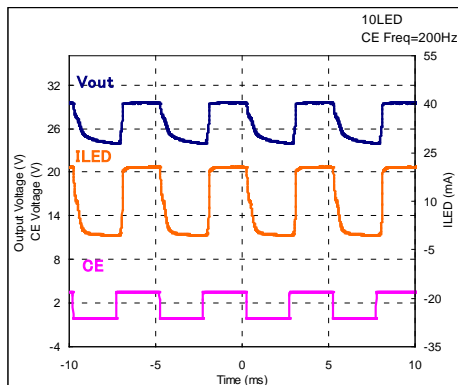

CE Freq = 10 kHz

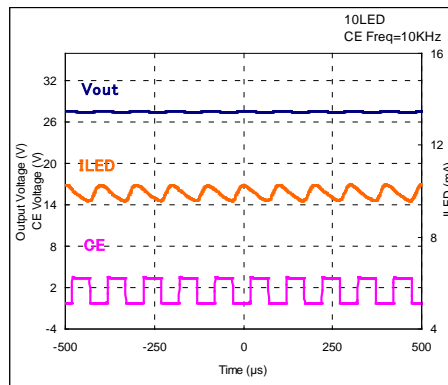

CE Freq = 300 kHz

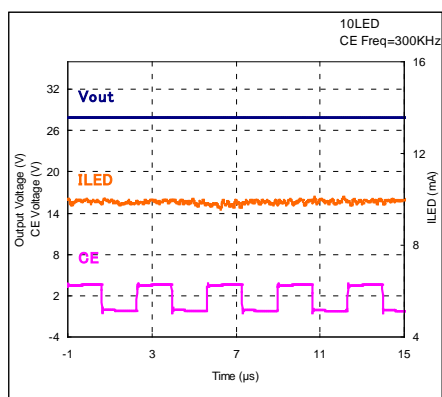

5) V_{OUT} Ripple ($V_{IN} = 3.6 \text{ V}$, $V_{SET} = 21 \text{ V}$, $I_{OUT} = 0 \text{ mA}$, $L = 10 \mu\text{H}$ (VLF302512MT-100M))

PWM Control (R1204xxxxB)

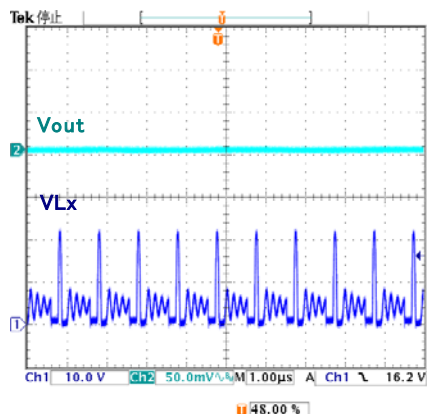

VFM Control (R1204xxxxC)

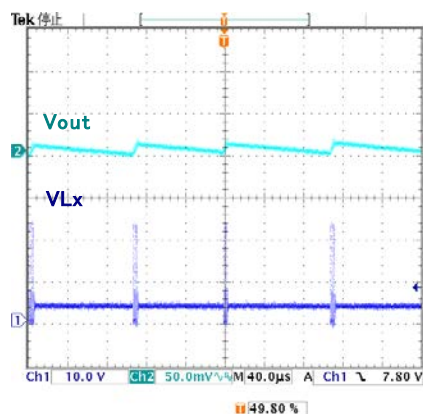

R1204x

No. EA-284-200901

6) Load Transient Response

($V_{IN} = 3.6\text{ V}$, $V_{SET} = 25\text{ V}$, $L = 10\text{ }\mu\text{H}$ (VLF302512MT-100M), $I_{OUT} = 10\text{ mA} \leftrightarrow 30\text{ mA}$, $T_r = T_f = 0.5\text{ }\mu\text{s}$)

R1204xxxxC

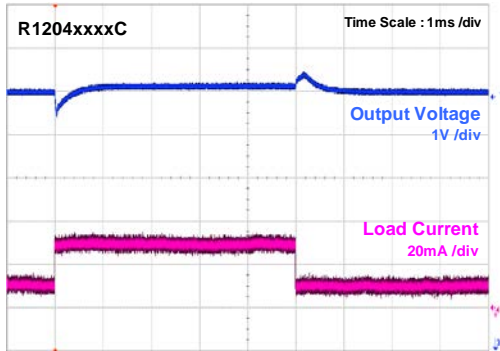

R1204xxxxF

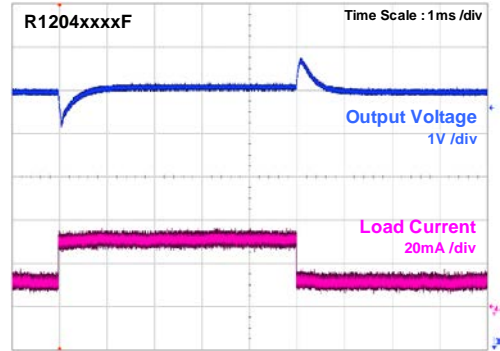

7) Supply Current vs. Ambient Temperature

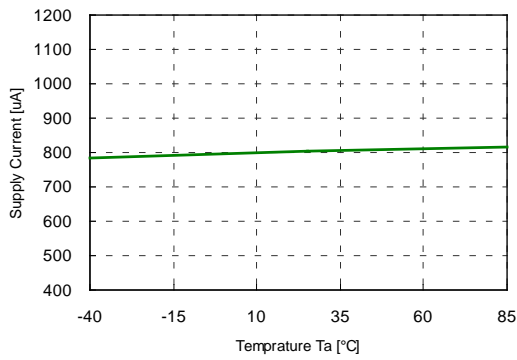

8) UVLO vs. Ambient Temperature

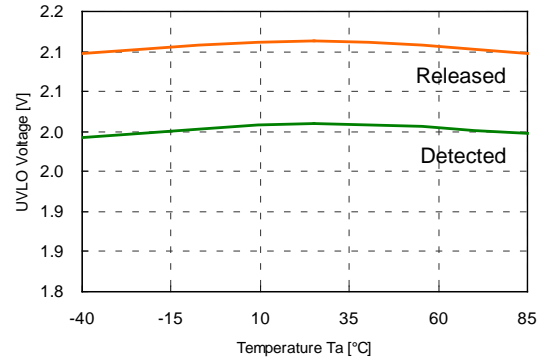

9) VFB Voltage vs. Ambient Temperature

R1204xxxxA/D

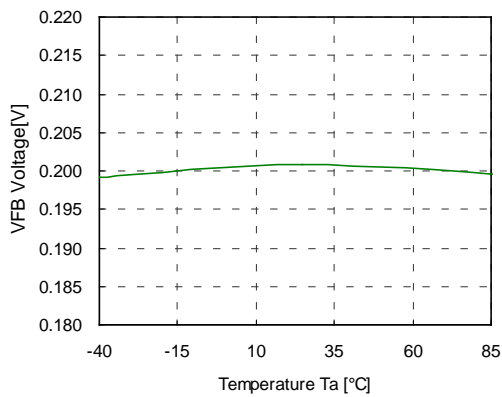

R1204xxxxG/H

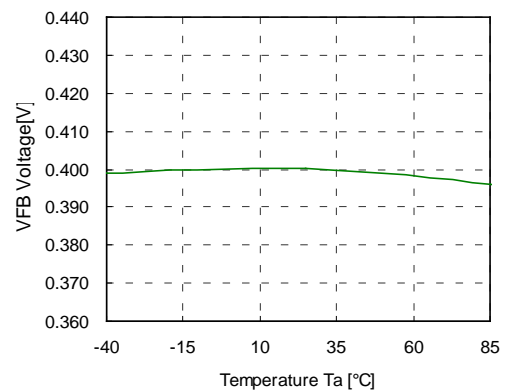

R1204xxxxB/C/E/F

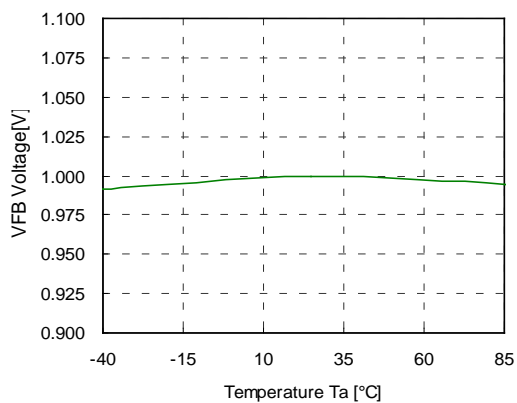

10) Switch ON Resistance vs. Ambient Temperature

R1204x3xxx

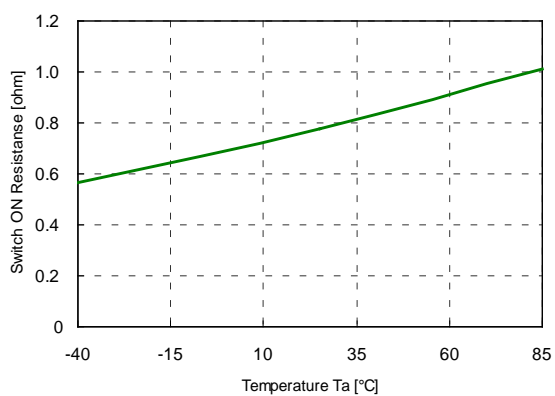

11) OVP Voltage vs. Ambient Temperature

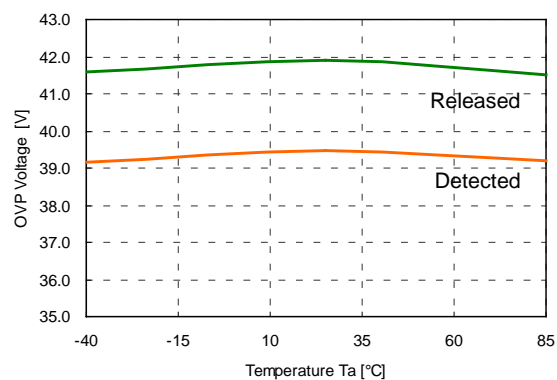

12) LX Limit Current vs. Ambient Temperature

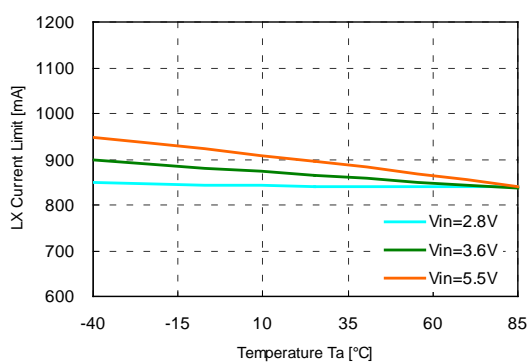

R1204x

No. EA-284-200901

13) Oscillator Frequency vs. Ambient Temperature

R1204xxxxA/B/C/G

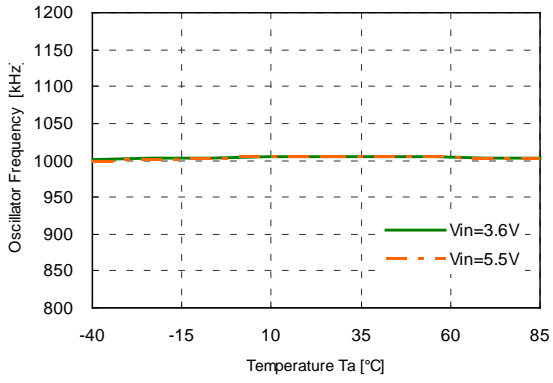

R1204xxxxD/E/F/H

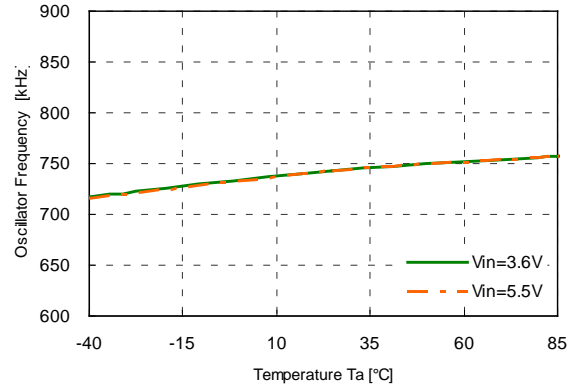

The power dissipation of the package is dependent on PCB material, layout, and environmental conditions. The following measurement conditions are based on JEDEC STD. 51-7.

Measurement Conditions

Item	Measurement Conditions
Environment	Mounting on Board (Wind Velocity = 0 m/s)
Board Material	Glass Cloth Epoxy Plastic (Four-Layer Board)
Board Dimensions	76.2 mm × 114.3 mm × 0.8 mm
Copper Ratio	Outer Layer (First Layer): Less than 95% of 50 mm Square Inner Layers (Second and Third Layers): Approx. 100% of 50 mm Square Outer Layer (Fourth Layer): Approx. 100% of 50 mm Square
Through-holes	φ 0.2 mm × 34 pcs

Measurement Result

(Ta = 25°C, Tjmax = 125°C)

Item	Measurement Result
Power Dissipation	2200 mW
Thermal Resistance (θ_{ja})	$\theta_{ja} = 45^{\circ}\text{C/W}$
Thermal Characterization Parameter (ψ_{jt})	$\psi_{jt} = 18^{\circ}\text{C/W}$

θ_{ja} : Junction-to-Ambient Thermal Resistance

ψ_{jt} : Junction-to-Top Thermal Characterization Parameter

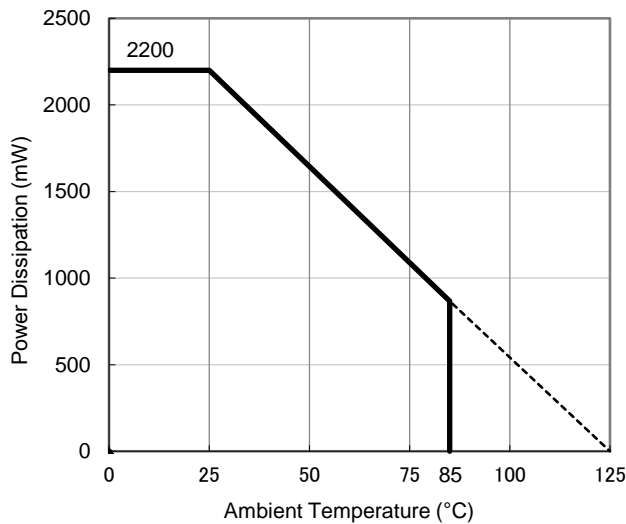

Power Dissipation vs. Ambient Temperature

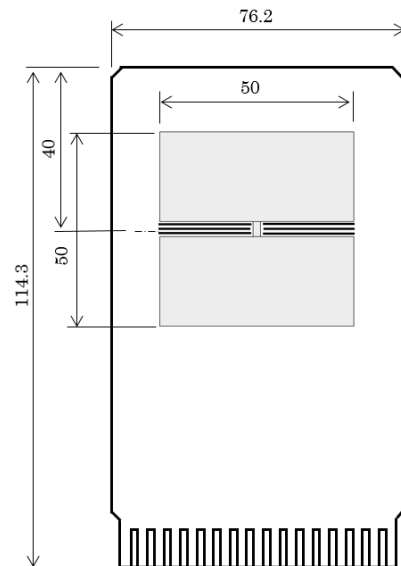

Measurement Board Pattern

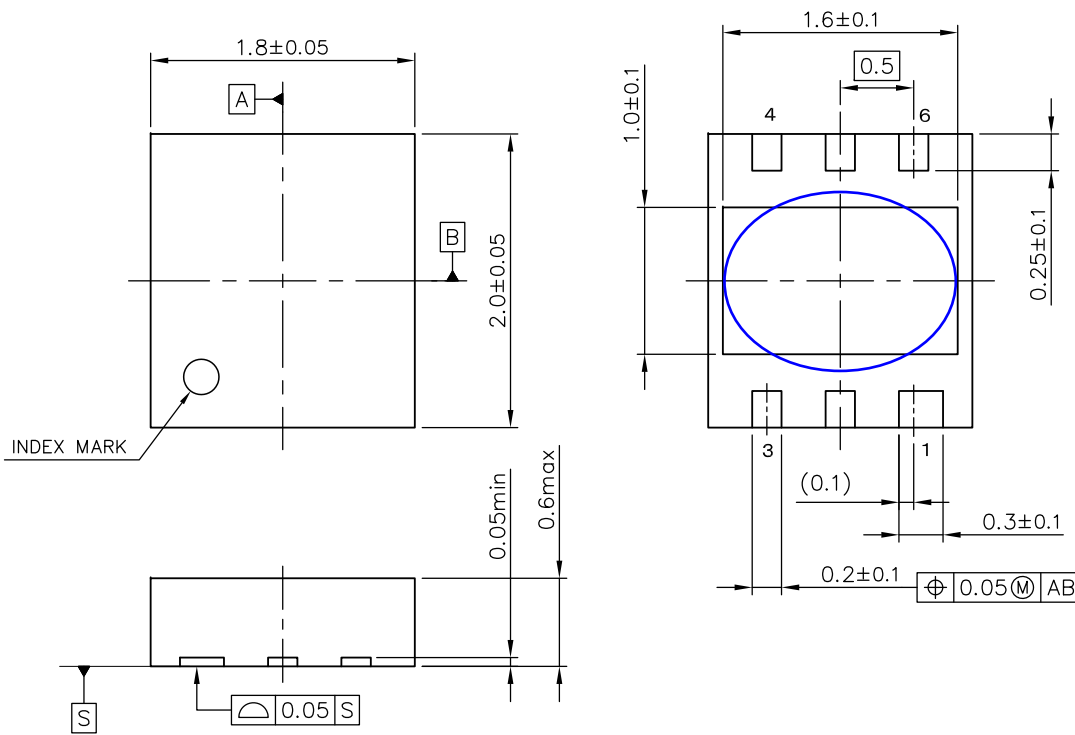

UNIT: mm

DFN(PLP)1820-6 Package Dimensions

* The tab on the bottom of the package is substrate level (GND). It is recommended that the tab be connected to the ground plane on the board, or otherwise be left floating.

The power dissipation of the package is dependent on PCB material, layout, and environmental conditions. The following conditions are used in this measurement.

Measurement Conditions

Item	Standard Test Land Pattern
Environment	Mounting on Board (Wind Velocity = 0 m/s)
Board Material	Glass Cloth Epoxy Plastic (Double-Sided Board)
Board Dimensions	40 mm × 40 mm × 1.6 mm
Copper Ratio	Top Side: Approx. 50% Bottom Side: Approx. 50%
Through-holes	φ 0.5 mm × 44 pcs

Measurement Result

(Ta = 25°C, Tjmax = 125°C)

Item	Standard Test Land Pattern
Power Dissipation	460 mW
Thermal Resistance (θja)	θja = 217°C/W
Thermal Characterization Parameter (ψjt)	ψjt = 40°C/W

θja: Junction-to-Ambient Thermal Resistance

ψjt: Junction-to-Top Thermal Characterization Parameter

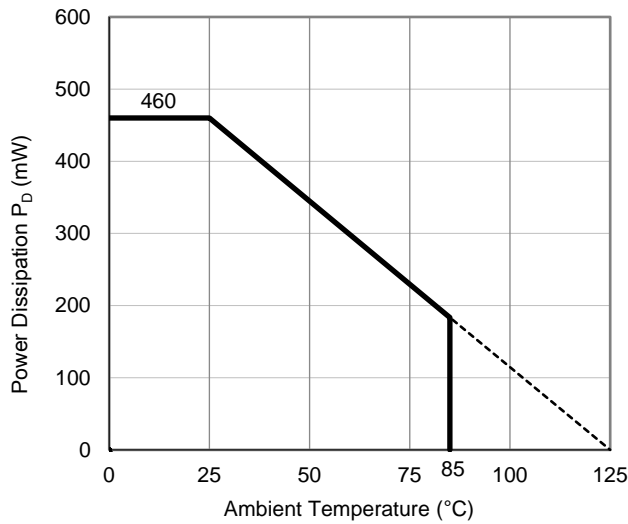

Power Dissipation vs. Ambient Temperature

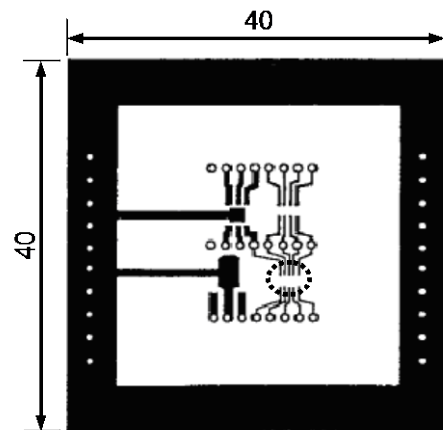

Measurement Board Pattern

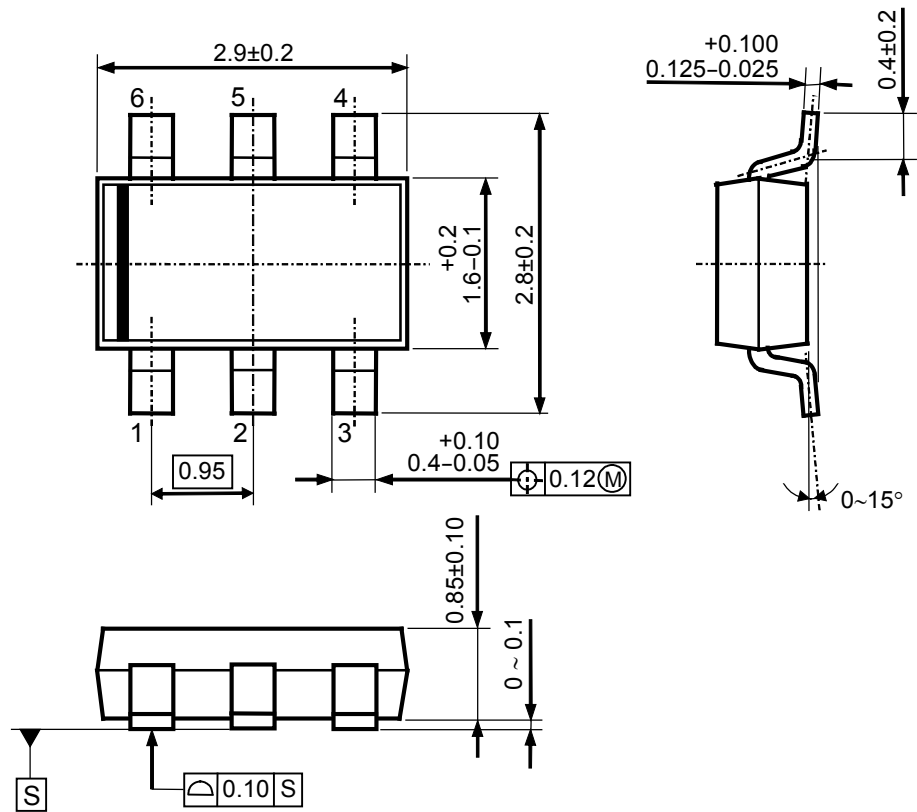

UNIT: mm

TSOT-23-6 Package Dimensions



1. The products and the product specifications described in this document are subject to change or discontinuation of production without notice for reasons such as improvement. Therefore, before deciding to use the products, please refer to Ricoh sales representatives for the latest information thereon.
2. The materials in this document may not be copied or otherwise reproduced in whole or in part without prior written consent of Ricoh.
3. Please be sure to take any necessary formalities under relevant laws or regulations before exporting or otherwise taking out of your country the products or the technical information described herein.
4. The technical information described in this document shows typical characteristics of and example application circuits for the products. The release of such information is not to be construed as a warranty of or a grant of license under Ricoh's or any third party's intellectual property rights or any other rights.
5. The products listed in this document are intended and designed for use as general electronic components in standard applications (office equipment, telecommunication equipment, measuring instruments, consumer electronic products, amusement equipment etc.). Those customers intending to use a product in an application requiring extreme quality and reliability, for example, in a highly specific application where the failure or misoperation of the product could result in human injury or death (aircraft, spacevehicle, nuclear reactor control system, traffic control system, automotive and transportation equipment, combustion equipment, safety devices, life support system etc.) should first contact us.
6. We are making our continuous effort to improve the quality and reliability of our products, but semiconductor products are likely to fail with certain probability. In order to prevent any injury to persons or damages to property resulting from such failure, customers should be careful enough to incorporate safety measures in their design, such as redundancy feature, fire containment feature and fail-safe feature. We do not assume any liability or responsibility for any loss or damage arising from misuse or inappropriate use of the products.
7. Anti-radiation design is not implemented in the products described in this document.
8. The X-ray exposure can influence functions and characteristics of the products. Confirm the product functions and characteristics in the evaluation stage.
9. WLCSP products should be used in light shielded environments. The light exposure can influence functions and characteristics of the products under operation or storage.
10. There can be variation in the marking when different AOI (Automated Optical Inspection) equipment is used. In the case of recognizing the marking characteristic with AOI, please contact Ricoh sales or our distributor before attempting to use AOI.
11. Please contact Ricoh sales representatives should you have any questions or comments concerning the products or the technical information.



Ricoh is committed to reducing the environmental loading materials in electrical devices with a view to contributing to the protection of human health and the environment.

Ricoh has been providing RoHS compliant products since April 1, 2006 and Halogen-free products since April 1, 2012.

RICOH RICOH ELECTRONIC DEVICES CO., LTD.

Official website

<https://www.n-redc.co.jp/en/>

Contact us

<https://www.n-redc.co.jp/en/buy/>

